



OUR STORY

Trolley and Cart was established in 1995 as a professional manufacturer of mobile hospitality equipment. Over the years, we recognized that there was a greater need for mobile equipment to not only be produced to the highest quality but also be aesthetical, cost-effective, sustainable and multifunctional. This notion drove us to set up TC Design Studio in 2017. By overseeing the entire process from the initial design through to final production, we invest heavily in research and develop new solutions that is able to offer great value-sourcing sustainable materials, building energy-efficient product ranges, exploring space-saving design and many other innovation possibilities. By partnering with international suppliers and distributors, Trolley and Cart is constantly looking for new and better ways forward. We adopt a consultative approach with our customers and collaborate with industry professionals in catering, hospitality and F&B to drive innovation forward and build for the future.

FOOD & BEVERAGE	001
FLEX	005
Deluxe lite	015
Deluxe	045
Mini Station	053
Modular System	057
Transportation Trolley	071
COFFEE BREAK	075
DNA Mobile Bar System	077
Cocktail table	095
Mobile Display	099
Coffee Cabinet	103
Nesting Table	109
SERVICE TROLLEY	117
ROOM	133
Alpha Housekeeping System	135
Terse M	161
Smart Trolley	162
Vincent Trolley	163
Room Service Trolley	165
FRONT HOUSE	169
Lobby Cart	171
Stanchion	175
Ash Bin	177
Signage Stand	181
BANQUET	183
Banquet Chair	185
Meeting Table	193
Banquet Table	195
Partition	199
Podium	201

F O O D & B E V E R A G E

F L E X

FLEX created the most recognizable images of buffet station and facilitate this idea to F&B industry. FLEX will be featured in TC new station collection presented in 2022.

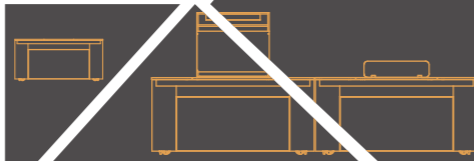
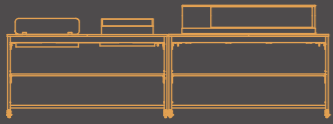

D E L U X E

As TC signature design, Deluxe is always chef's first choice. TC choose #304 stainless steel to form Deluxe, which created Deluxe unique durability and stable performance.



D E L U X E L I T E

The very first idea came to us when designing Deluxe Lite is making it as multipurpose as we can. We found out a lot of mobile stations are not easily maneuver, some even come without casters. High mobility built our very first design idea of Deluxe Lite. By partly using aluminum in this station body, Deluxe Lite achieved a good balance point between stability and maneuverability. It perfectly present most features of Deluxe while keep its own personality.

M I N I S T A T I O N

Change means we see the world in different perspective, change also challenge the world to accept new ideas. As we build up MINI Station, we face this challenge frequently. MINI Station perfectly match all TC Stations, we invite you to join us for the Journey of Change.

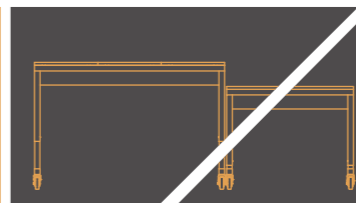

MOBILE STATION COLLECTION

As an agitator, designer, and theorist, TC work fearlessly to explore the boundary between creativity and adaptability.

From kitchen to ballroom, live cooking to catering, we are inspired by the idea of providing mobile F&B service with food trucks and buffet stations.

After 5 years and thousands of testing, we present you our TC Mobile Station Collection Deluxe which is the Deluxe Lite, FLEX and MINI Station. These are the dynamic union of mobile stations with the maximum connection of function and aesthetics.



Flex



Deluxe Lite



Deluxe Lite + Bar Modular



Deluxe



MINI Station

FLEX

Mobile Station

FLEX created the most recognizable images of buffet station and facilitate this idea to F&B industry.

FLEX will be featured in TC new station collection presented in 2022.



FLEX

Grace of Lightness



100% Anodized aluminum alloy frame

Anodized Aluminum Frame is 66% lighter than #304 stainless steel frame.

Premium laminate

Certified by Greenguard, Leed, FSC etc., heat and scuff resistance with unique decorative surface that offers various stone and woodgrain patterns in a wide attractive range of finishes

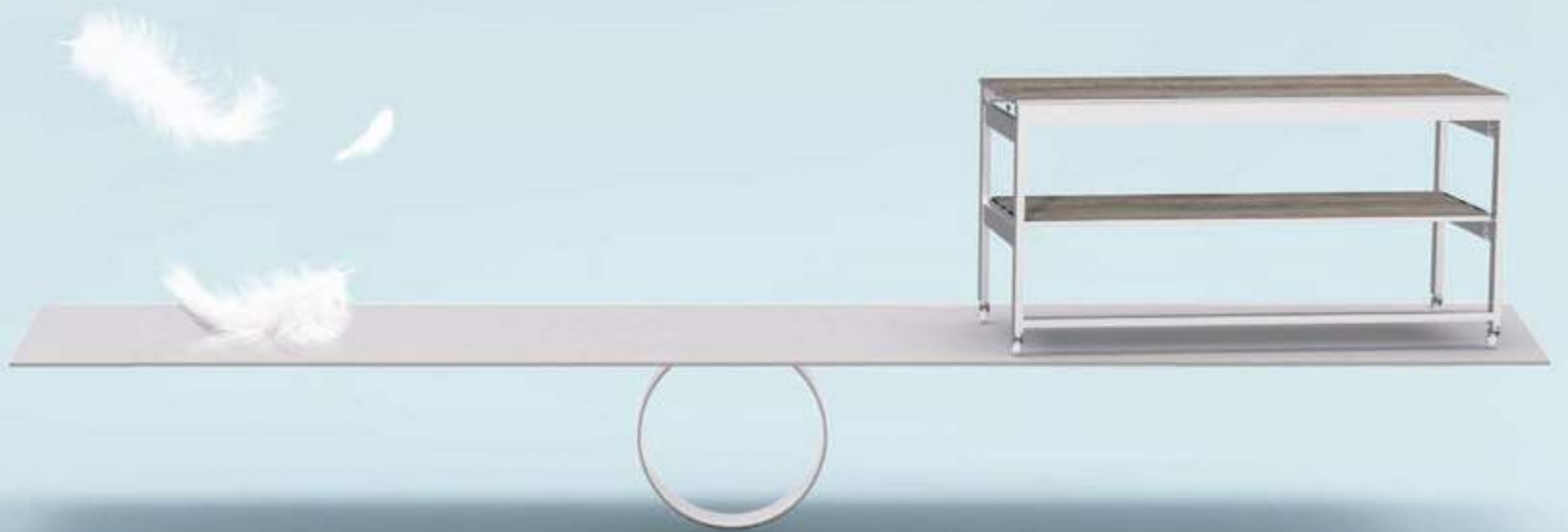

Anti-rust
Anti-corrosion



Light-weight



Scratch
resistance



Weatherproof



Heatproof



Durable

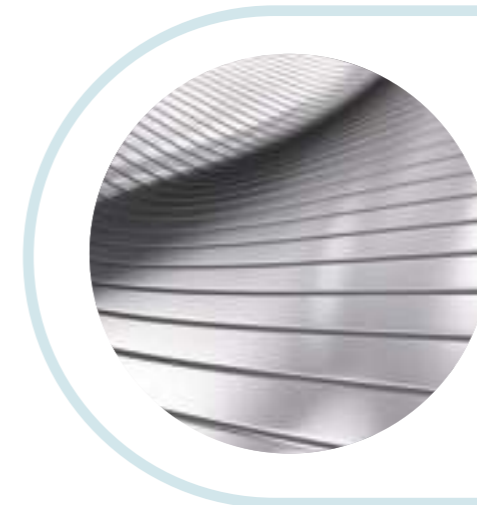

Anodized aluminum alloy frame is 66% lighter than #304 stainless steel frame.

ρ AL Alloy = 2.7g/cm³
 ρ S/S = 7.93g/cm³



Anodized Aluminum Silver



Anodized Aluminum Rosegold



Anodized Aluminum Brown



Anodized Aluminum Black

FLEX

Safety Circuit Design

This bar is designed to eliminate all potential hazards by using high power cooking devices and minimizing maintenance and repair cost. Built-in 4 individual electrical supply sets include weatherproof and dust-tight 10A universal socket with overload circuit breaker and aviation connector plug in each set.



Universal Adaptor



ELCB adaptor



Overheat protection



Overloading Protection



Triple-core wire (ground protection)



Aviation Plug



Removable



Fast Update



UL



CE



CCC

Best Efficiency

Easy to assemble in ONE minute by ONE person and also easy to use by reducing daily operational errors.



REAR VIEW

Sliding Power Bar

-The bar integrated all the electrical parts, could be easily sliding in and out smoothly for quick station setup and knock down.



SIDE VIEW



Swing Folding

-Folded unit saves 81% space less than fully assembled unit.



Step 1



Step 2



Step 3



FLEX

Multi-Purpose

Functional Panel

Functional panels are designed to be the dish rack or to be the front decoration covers of the station. Variety combinations fulfill various set up requirements.

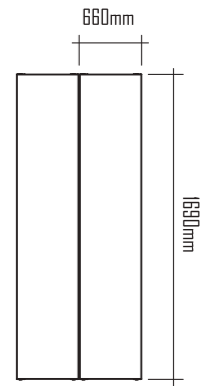

2 x 1/2 Dish Panel

3 x 1/2 Dish Panel

4 x 1/2 Dish Panel



Matal & Laminate



• Matal: Anodized Aluminum Black
AL-BLK06
Laminate: DWND1



• Matal: Anodized Aluminum Silver
AL-S01
Laminate: DWN10



• Matal: Anodized Aluminum Brown
AL-BRN05
Laminate: DWN06



• Matal: Anodized Aluminum Rosegold
AL-R02
Laminate: DWN12

Laser Cutting



FPLC01

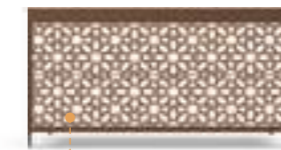

FPLC03



FPLC19



FPLC05

Front Panel



The very first idea came to us when designing Deluxe Lite is making it as multipurpose as we can. We found out a lot of mobile stations are not easily maneuver, some even come without casters. High mobility built our very first design idea of Deluxe Lite. By partly using aluminum in this station body, Deluxe Lite achieved a good balance piont between stability and maneuverability. It perfectly present most features of Deluxe while keep its own personality.







Multipurpose

By taking maximum advantage of the high mobility and modular system, this station is perfect for outdoor catering and indoor events. It will help create more F&B revenue without location limitation.



DELUXE LITE



Applicable to Different Scenarios

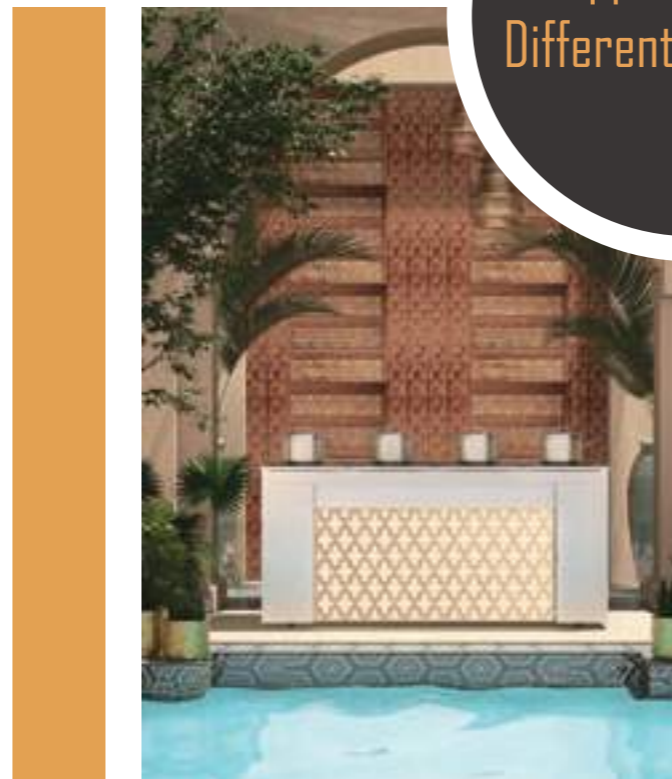

Cost Efficiency

Built in side panels, dish rack and 6 invisible castors, all of those are designed to achieve cost efficiency based on our ONE design philosophy. No need to purchase any other accessories for daily operation.

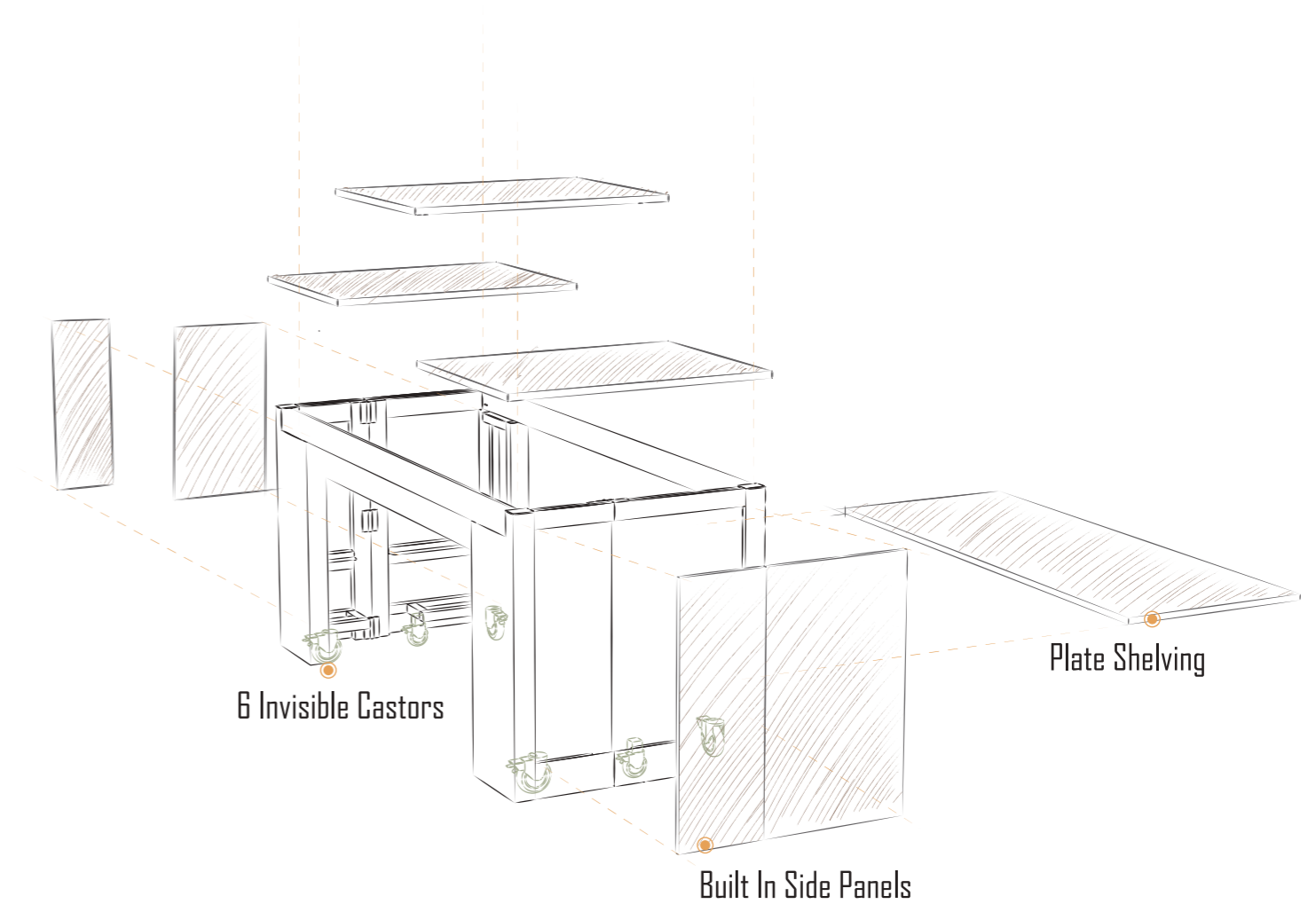

Built To Last

Weatherproof Material



DELUXE LITE

Anodized aluminum alloy frame



Anti-rust
Anti-corrosion



Light-weight



Scratch
resistance

With the most durable surface finishes, this frame is anti-rust, scratch resistance and aesthetic appearance while 66% lighter than stainless steel .

Water resistant plywood body



Weatherproof



Heatproof



Durable

Compacted solid wood with high-quality waterproof glue, that well balanced in weight and strength, we use this material to build mobile station and modules body.

Premium laminate



Certified by Greenguard, Leed, FSC etc., heat and scuff resistance with unique decorative surface that offers various stone and woodgrain patterns in a wide attractive range of finishes.

Frame Weight

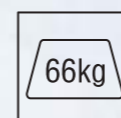

DELUXE LITE

High Mobility

6 built-in synthetic rubber swivel wheels, they are quiet, heavy duty, non-marking and resistant to cleaning chemicals, floor polishes, oil, grease, solvents, and water. Offer excellent weight support and floor protection.



4x3" Castors



2x2" Castors



2 Swivel Castors
With Brakes

6 built-in synthetic rubber swivel wheels



Anti-rust
Anti-corrosion



Non-marking

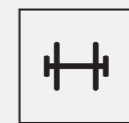

Heavy Duty



Quiet



EP

DELUXE LITE



2

3

4

ONE person, 3 steps, Easy set up

Folding Demonstration

Step 1 Detachable Module Tops

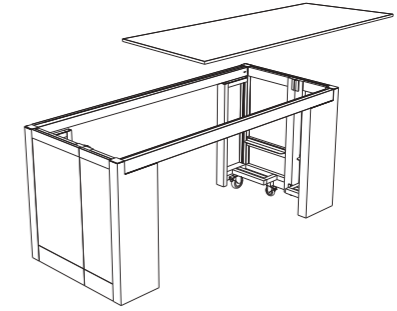

Step 2 Removable Power Bar

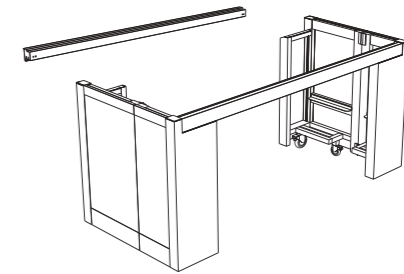

Step 3 Swing Folding

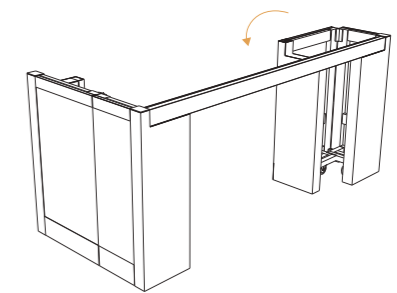

Done Lock & go

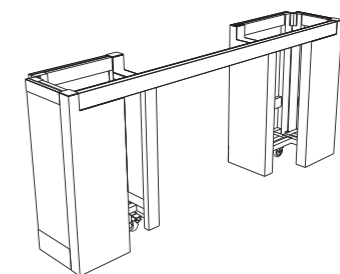

DELUXE LITE



Space Saver

Folding Wings Design, ideal for small storage outlets, boutique hotels and small restaurants, save 57% rooms than assembled unit.

DELUXE LITE

Retractable universal plug module wire

Removable 4 aviation connector cables

Overall Protection of Electrical Safety

Removable Power Bar



Current Division



4 aviation cables



Removable

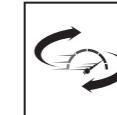

Fast Update

This bar is designed to eliminate all potential hazards in using high power cooking devices and minimizing maintenance and repair cost. Built-in 4 individual electrical supply sets include weatherproof and dust-tight IOA universal socket with overload circuit breaker and aviation connector plug in each set.

Removable 4 aviation connector plugs

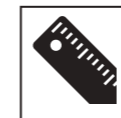

Length



Temperature Range



Triple-core wire (ground protection)



UL



CE



CCC

1.5m /5' long, certified by UL/CE/CCC, screw-lock structure, Ø1.5-2.5mm triple-core wire, impact resistance, safe use in harsh environment (-40°C--75°C / -40°F--167°F). One side connect to the bar, another side connect to ELCB adopter.

ELCB adopter



Universal Adaptor



ELCB adopter



Overheat protection



Overloading Protection

IOA/16A Earth-leakage circuit breaker are added extra protection against the risk of electric shock. It instantly cuts the power in the event of an earth connection leakage.

Color Selection

Color is the initial impression of each product. The visual texture largely determine our feeling of products. Sometimes aesthetic is under the light and reflection. By choosing different panel colors, textured finishes and different frames, you can give each mobile station its own character.

Frame



Laminate



Front Panel-Laser Cutting



DELUXE LITE



FPLC01



FPLC02



FPLC03



FPLC04



FPLC05

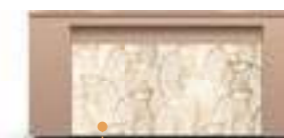

FPLC06

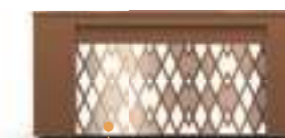

FPLC07

Front Panel-Artistic Painting



DELUXE LITE

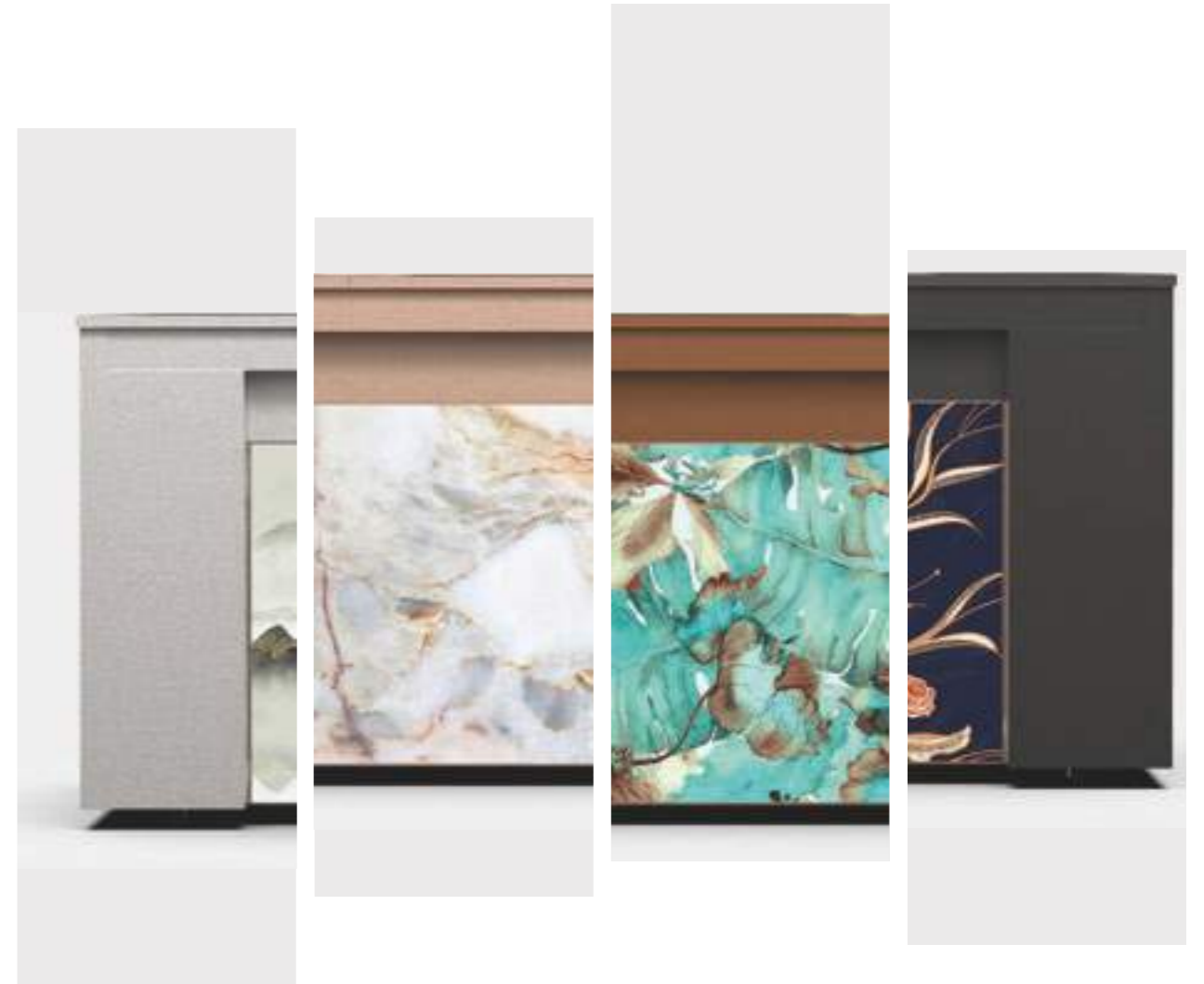

FPLC07

FPLC08

FPLC09

FPLC10

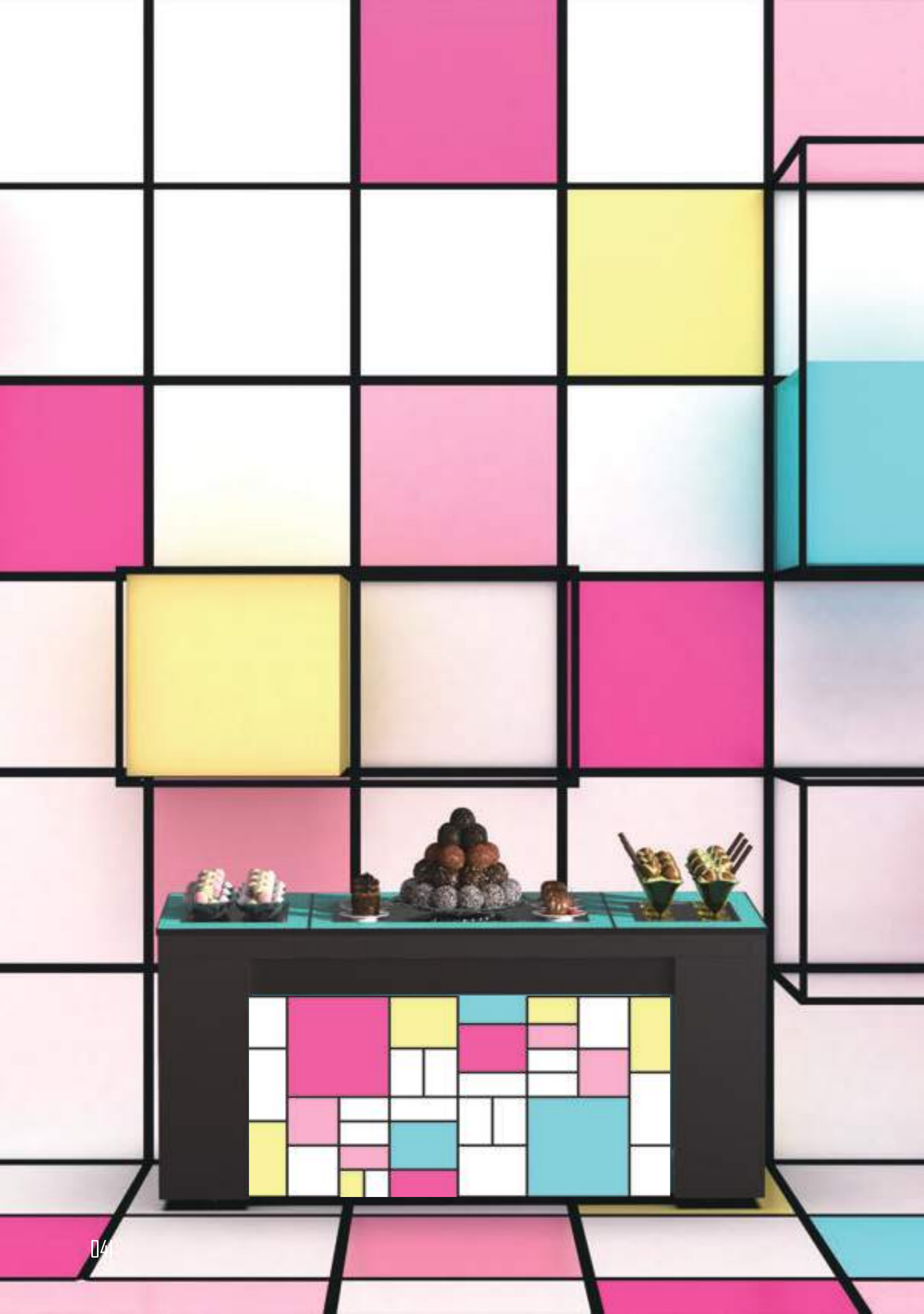

DELUXE LITE

Front Panel-Customized Design

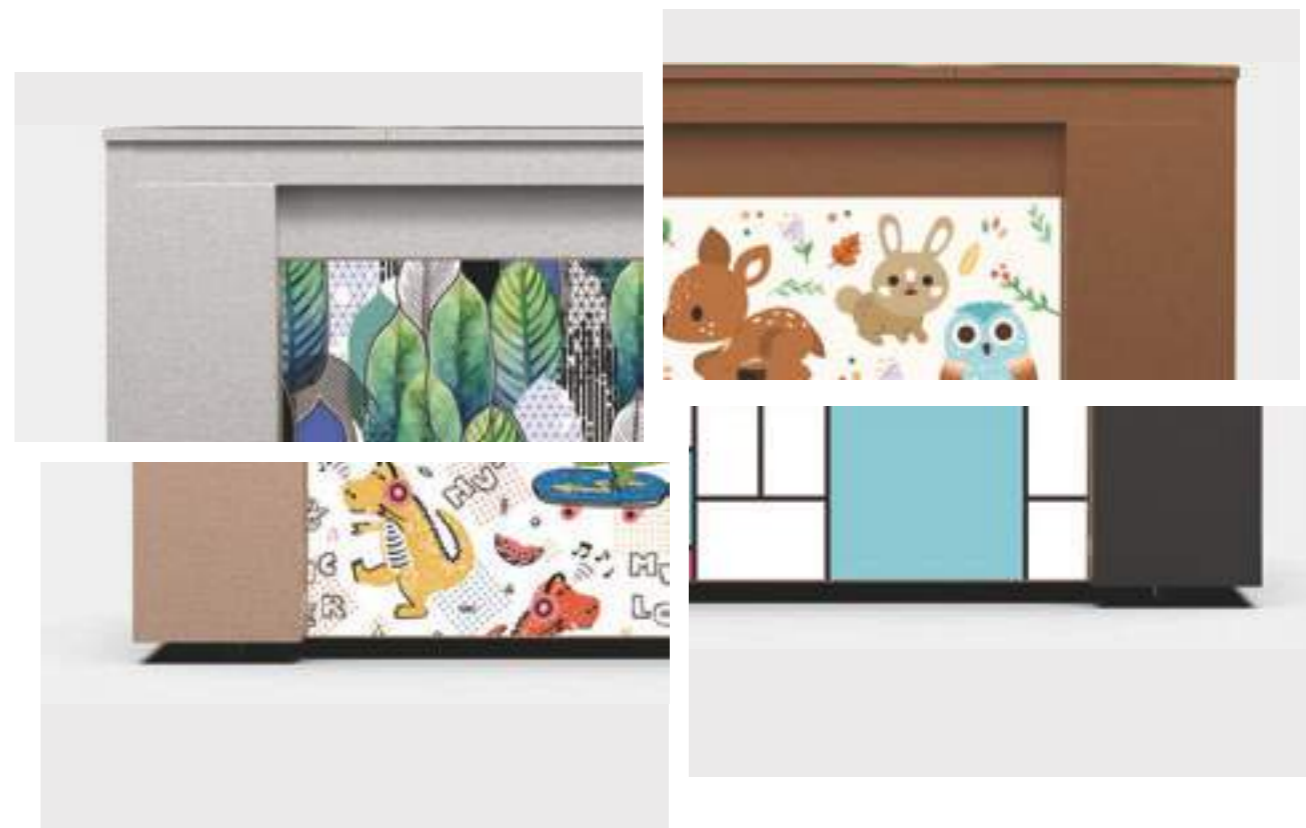

FPLC11

FPLC12

FPLC13

FPLC14



FPLC11

FPLC12

FPLC13

FPLC14

DELUXE

As TC signature design, Deluxe is always chef's first choice. TC choose #304 stainless steel to form Deluxe, which created Deluxe unique durability and stable performance.

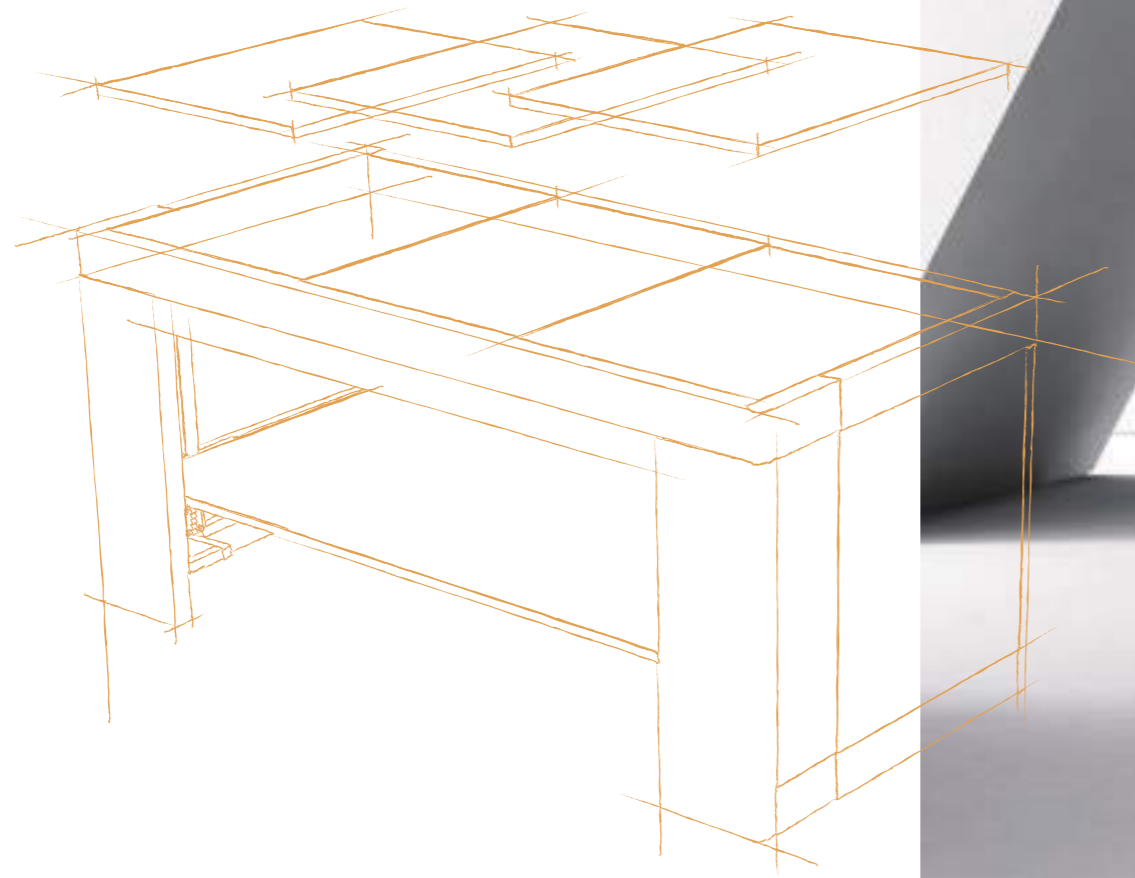

Outlets



5" Castors



4 Swivel Castors



2 Swivel Castors
With Brakes

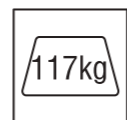

Frame Weight

Stainless steel options



Brushed S/S
SSB



Brushed S/S-Rose Gold Electroplated
SSB-ERG

Laminate options



DWN02



DWN10



DWN01





URBAN

DELUXE

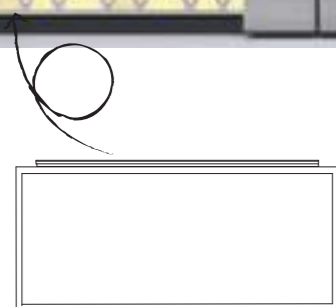

*LED Front Panel
(1/1 Unit)*

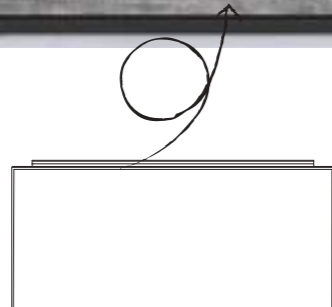

*Laminate Front Panel
(1/1 unit)*

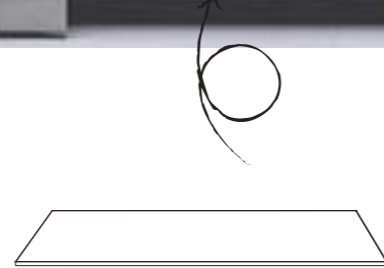
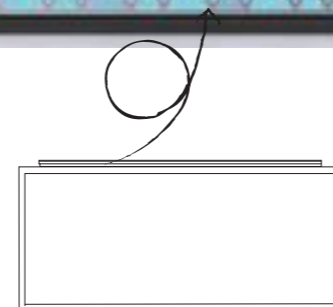

Plate shelving



*LED Front Panel
(1/1 Unit)*

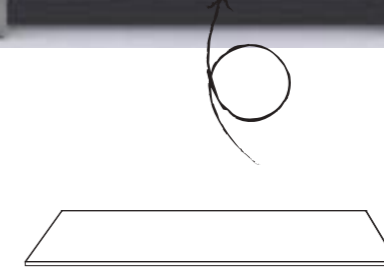
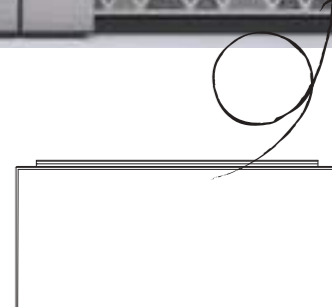

Plate shelving



*Laminate Front Panel
(1/1 unit)*

MINI STATION

Change is IN

Change means we see the world in different perspective, change also challenge the world to accept new ideas. As we build up MINI Station, we face this challenge frequently.

MINI Station perfectly match all TC Stations , we invite you to join us for the Journey of Change.



MINI STATION



- Nesting design
- High mobility with castors
- Interchangeable module tops
- Compatible with modular system
- Adjustable height

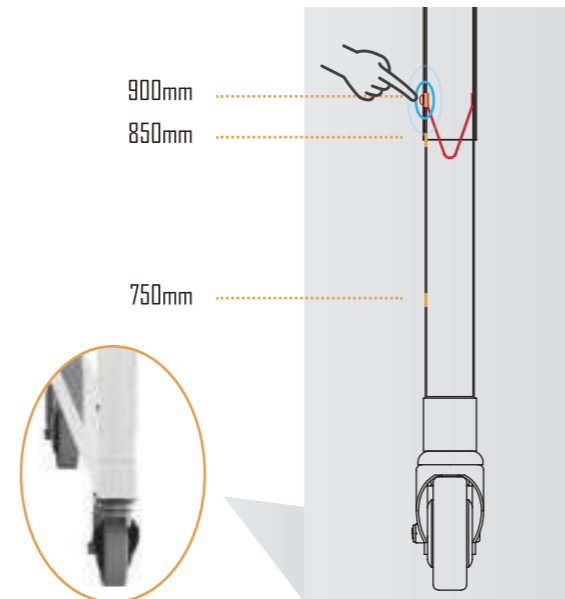

	CODE	SIZE
	MN00000L	L1350×W800×H900mm
	MN00000L	L1350×W800×H850mm
	MN00000L	L1350×W800×H750mm



	CODE	SIZE
	MN00000S	L900×W800×H900mm
	MN00000S	L900×W800×H850mm
	MN00000S	L900×W800×H750mm

Modular System

Thinking out of the box

We searched for a way to break through the boundaries of functional extension in F&B equipment, which could achieve cost efficiency and creativity freedom for chefs. The answer we found is this Modular System.

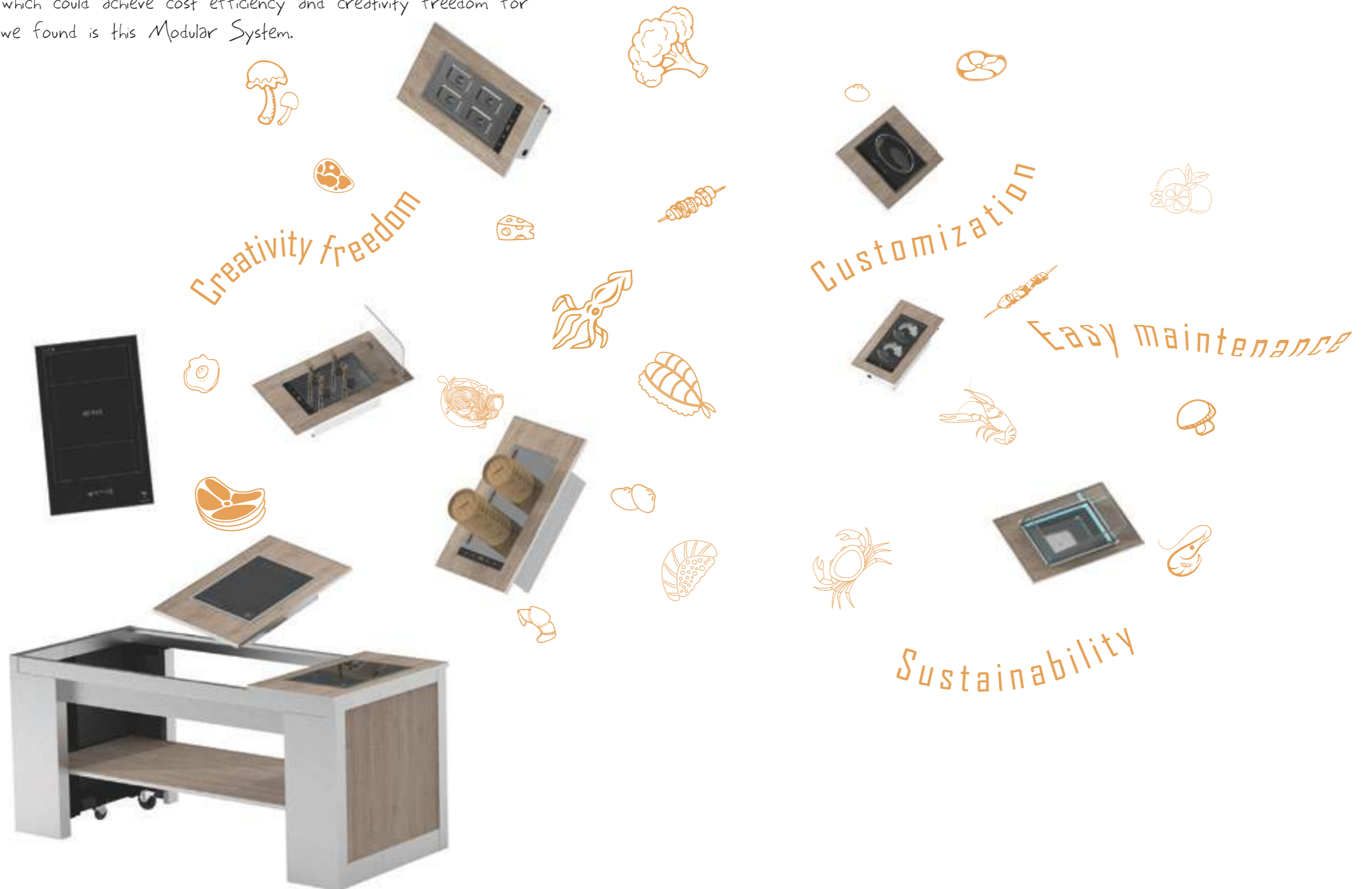
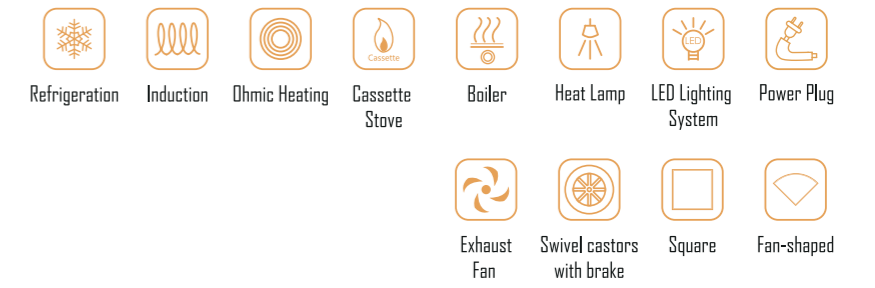



BBQ Station
- Plain module (1x/2 unit)
- Carving module (1x/2 unit)

Specific
Buffet
Combination



Fryer Station
- Full screen hot plate module (2x/4 unit)
- Fryer module (1x/2 unit)



Casserole Station
- Casserole module (4x/4 unit)

Wok Station
- Plain module (2x/4 unit)
- Plain module (1x/2 unit)



Seafood Salad Station
- Ice display module (3x/3 unit)

Western
Buffet
Combination



Pasta Station
- Ice display module (1x/3 unit)
- Sauce warmer module (1x/3 unit)
- Induction module (1x/3 unit)

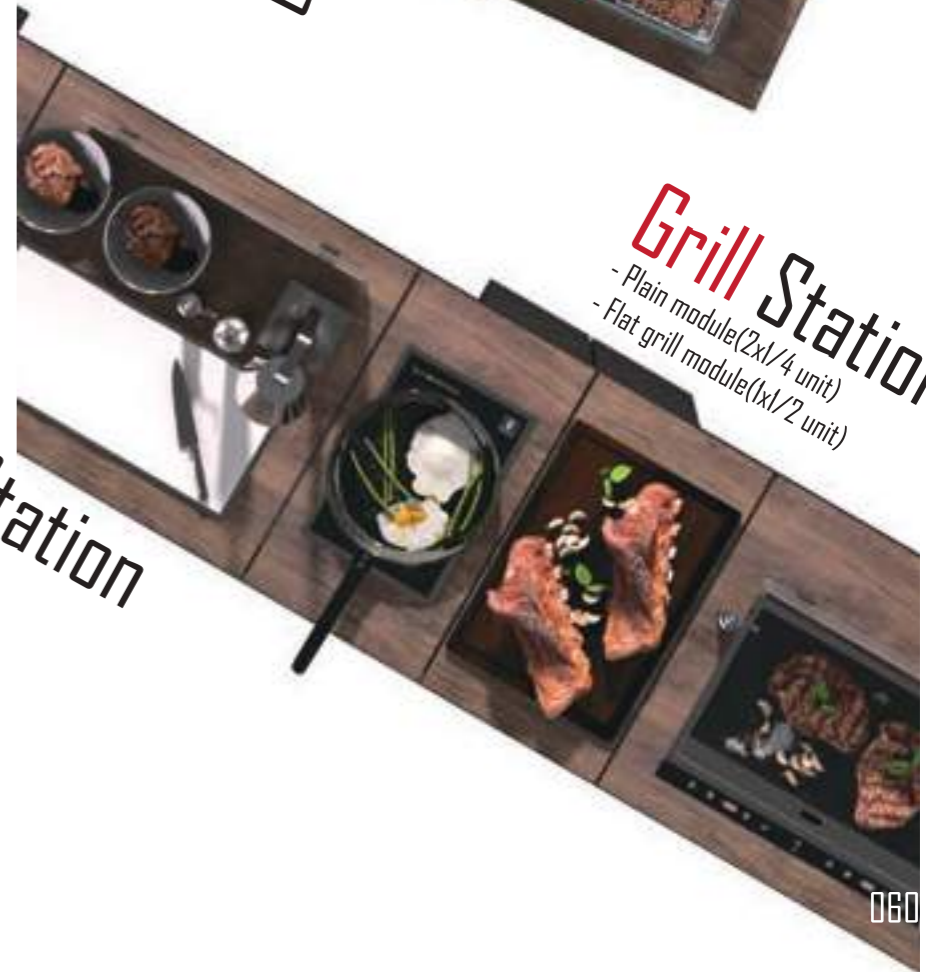

Grill Station
- Plain module (2x/4 unit)
- Flat grill module (1x/2 unit)

Carving Station
- Induction module (2x/4 unit)
- Carving module (1x/2 unit)

Japanese Buffet Combination



Seafood Salad Station
- Ice display module(2x1/4 unit)
- Ice display module(1x1/2 unit)

Fryer Station
- full screen hot plate module(2x1/4 unit)
- fryer module(1x1/2 unit)

Sushi Station
- sushi display module(1x1/1 unit)

Induction Cooking Station
- Induction module(3x1/3 unit)



Dessert Combination

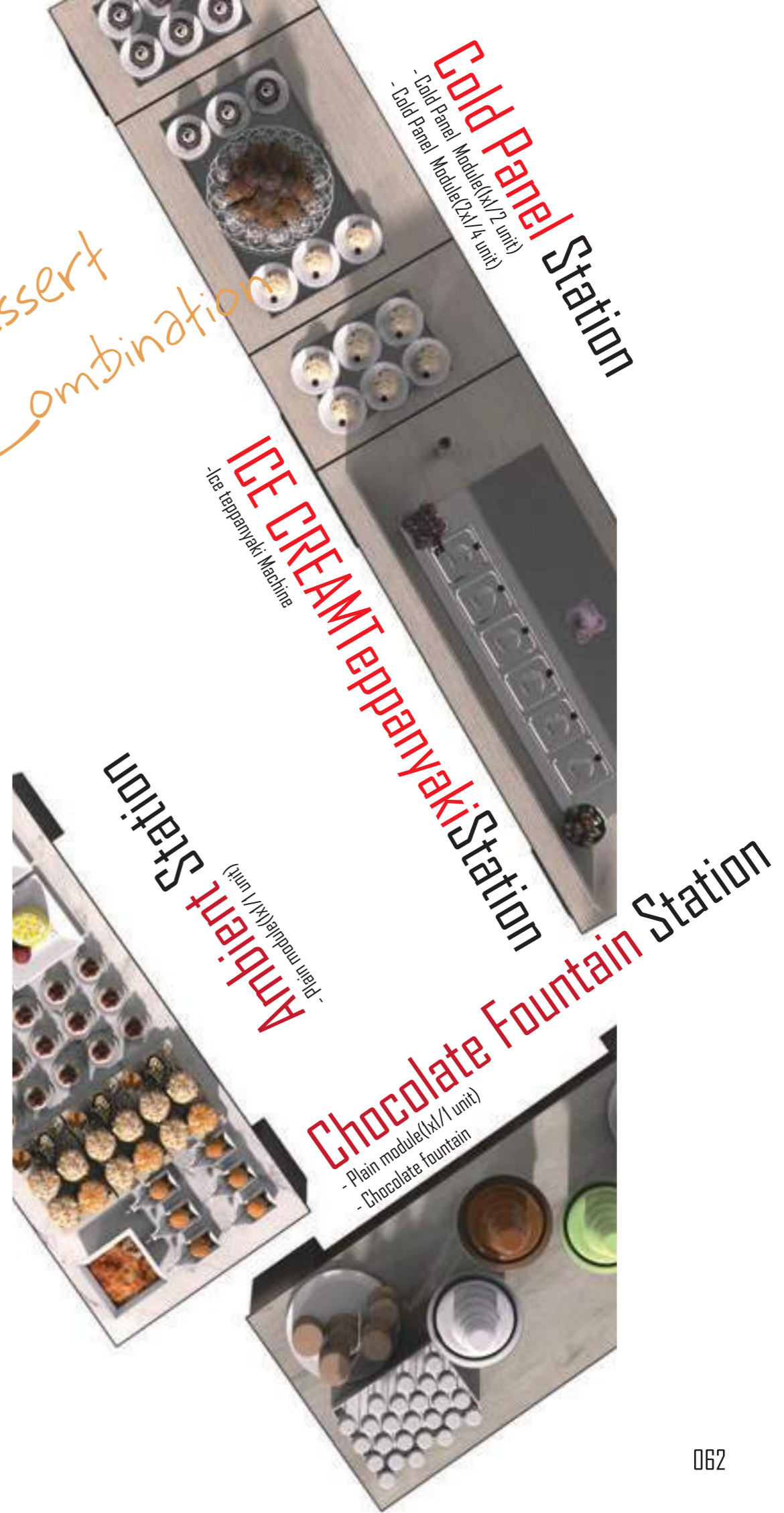

Cold Panel Station
- Cold Panel Module(1x1/2 unit)
- Cold Panel Module(2x1/4 unit)

ICE CREAM Teppanyaki Station
- Ice Teppanyaki Machine
- Plain module(1x1/1 unit)

Ambient Station

Chocolate Fountain Station
- Plain module(1x1/1 unit)
- Chocolate fountain

Chinese Buffet Combination



Noodle Station

- Soup module(x)/3 unit)
- Noodle cooking module(x)/3 unit)
- Sauce warmer module(x)/3 unit)



BBQ Station

- Induction module(2x)/4 unit)
- Bbq module(x)/2 unit)



Dim Sum Station

- Dim sum unit(x)/4 unit)
- Plate warmer unit(x)/4 unit)

Soup Station

- Soup boiler module(3x)/3 unit)



Buffet Station Set Up COMBINATIONS



1/1 Modules

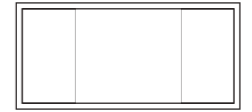

1/2+1/4 Modules

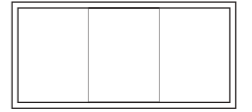

1/3 x 3 Modules

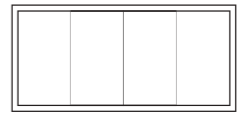

1/4 x 4 Modules

Modular System



1/1	1/2	1/3	1/4
L1800×W800mm L70.9"×W31.5"	L900×W800mm L35.4"×W31.5"	L600×W800mm L23.6"×W31.5"	L450×W800mm L17.7"×W31.5"



Plain Module
M80004
1/1 1/2 1/3 1/4



Induction Module
M80103
1/3 1/4
 > 220V/50HZ;
 > 1/3 & 1/4: 2.2Kw;
 > 120-240 °C



Sushi Module
M81401
1/1
 > 220V/50HZ;
 > 180W;
 > 0-12 °C



Ice Display Module
M81303
1/1 1/2 1/3 1/4
 > 220V/50HZ;
 > 1/1: 40W, 1/2: 30W,
 1/3: 20W, 1/4: 10W;

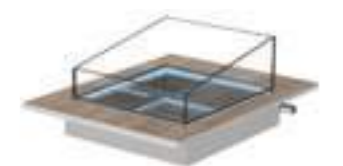

Flat Grill Module
M81102
1/2
 > 220V/50HZ;
 > 4.8kw;
 > 50-320 °C



Flat Grill+Ductless Vent
Hood Module
M11702
1/2
 > 220V/50HZ;
 > 4.8kw+3kw;
 > 30-300 °C;



Fryer Module
M81204
1/4
 > 220V/50HZ;
 > 1/4: 1600W;
 > 30-300 °C;



Cold Panel Module
M11902
1/2 1/4
 > 220V/50HZ;
 > 1/2: 1440W, 1/4: 720W;
 > 5-8 °C;



BBQ Module
M81502
1/2
 > 220V/50HZ;
 > 200W;



Carving Module
M81602
1/2



Modular System



1/1	1/2	1/3	1/4
L1800×W800mm L70.9"×W31.5"	L900×W800mm L35.4"×W31.5"	L600×W800mm L23.6"×W31.5"	L450×W800mm L17.7"×W31.5"

Full Screen Hot Plate Module
M80502

1/4

- › 220V/50HZ;
- › 400w;
- › 60-90 °C ;



Noodle Cooking Module
M80803

1/3 1/4

- › 220V/50HZ;
- › 1/3 & 1/4: 2.8kw;
- › 30-100 °C ;



Plain Side Station
DLS0201



Intelligent Sterilizing Plate Warmer Side Station
DLS0205

- › 220V/50HZ;
- › 400w;
- › 30-85 °C ;

Soup Module
M81003

1/3 1/4

- › 220V/50HZ;
- › 1/3 & 1/4: 2kw;
- › 30-100 °C ;



Dim Sum Module
M80703

1/3 1/4

- › 220V/50HZ;
- › 1/3 & 1/4: 2kw;
- › 30-100 °C ;



Plain Side Station
DLS0101



Seafood Side Station-Square
DLS0203

- › 220V/50HZ;
- › 20w;

Sauce Warmer Module
M80904

1/3 1/4

- › 220V/50HZ;
- › 1/3 & 1/4: 2kw;
- › 30-100 °C ;



Casserole Module
M11804

1/4

- › 220V/50HZ;
- › 1/3 & 1/4: 800W;



Induction Side Station-Square
DLS0202

- › 220V/50HZ;
- › 2.2kw;



LED Sneeze Guard
DLA0902

- › 220V/50HZ;
- › 10w;

Wok Module
M80603

1/3 1/4

- › 220V/50HZ;
- › 1/3 & 1/4: 2.6kw;



Plate Warmer Side Station-Square
DLS0204

- › 220V/50HZ;
- › 400w;
- › 30-85 °C ;



Range Hood Station
DLA1000

- › 220V/50HZ;
- › 42w;

Modular System

Bar Modular

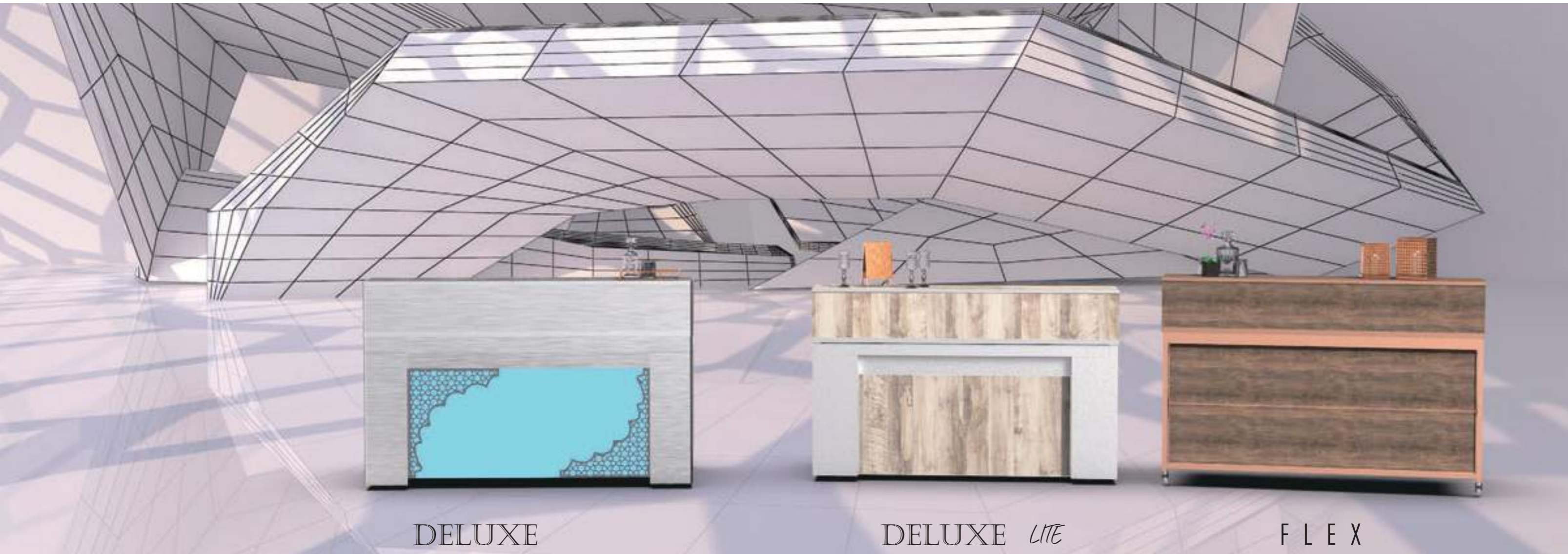

DELUXE

DELUXE *LITE*

FLEX



CODE : DLAI300
SIZE : L1800×W800×H320mm

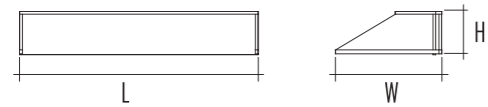

069



CODE : DA1300
SIZE : L1900×W900×H320mm

Laminate options



LED lighting system



070

Transportation Trolley

Module Trolley

- » Code: TRM01
- » Size: L873×W960×H1950mm



Front Panel & Shelving Panel Trolley

- » Code: TRDLP01
- » Size: L1750×W710×H1000mm

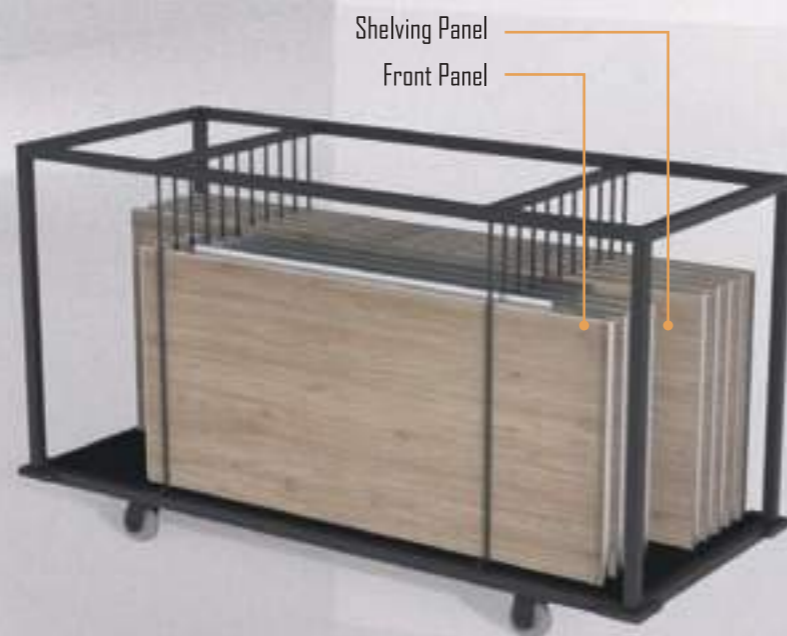

Multipurpose Trolley

- » Code: TRM00
- » Size: L1270×W980×H2000mm



Transportation Trolley



FLEX-Front Panel Trolley

- » Code: TRFP01
- » Size: L900×W900×H1780mm



FLEX-Frame Trolley

- » Code: TRFF01
- » Size: L1920×W950×H1960mm

FLEX-Frame Trolley
TRFF01



FLEX Front Panel(1/2)

FLEX Front Panel(1/4)



FLEX Frame

C O F F E E B R E A K

DNA MOBILE BAR SYSTEM

This mobile system free those talented Barista and Bartender for providing professional beverage services everywhere now, indoor/outdoor, from dirty coffee to old fashion. Combined with quarter bar, straight bar, side bar and back bar, DNA Mobile Bar System can make this unique working station into many different shapes and sizes. Assembled in minutes by different functional, bars fit almost any settings imaginable.

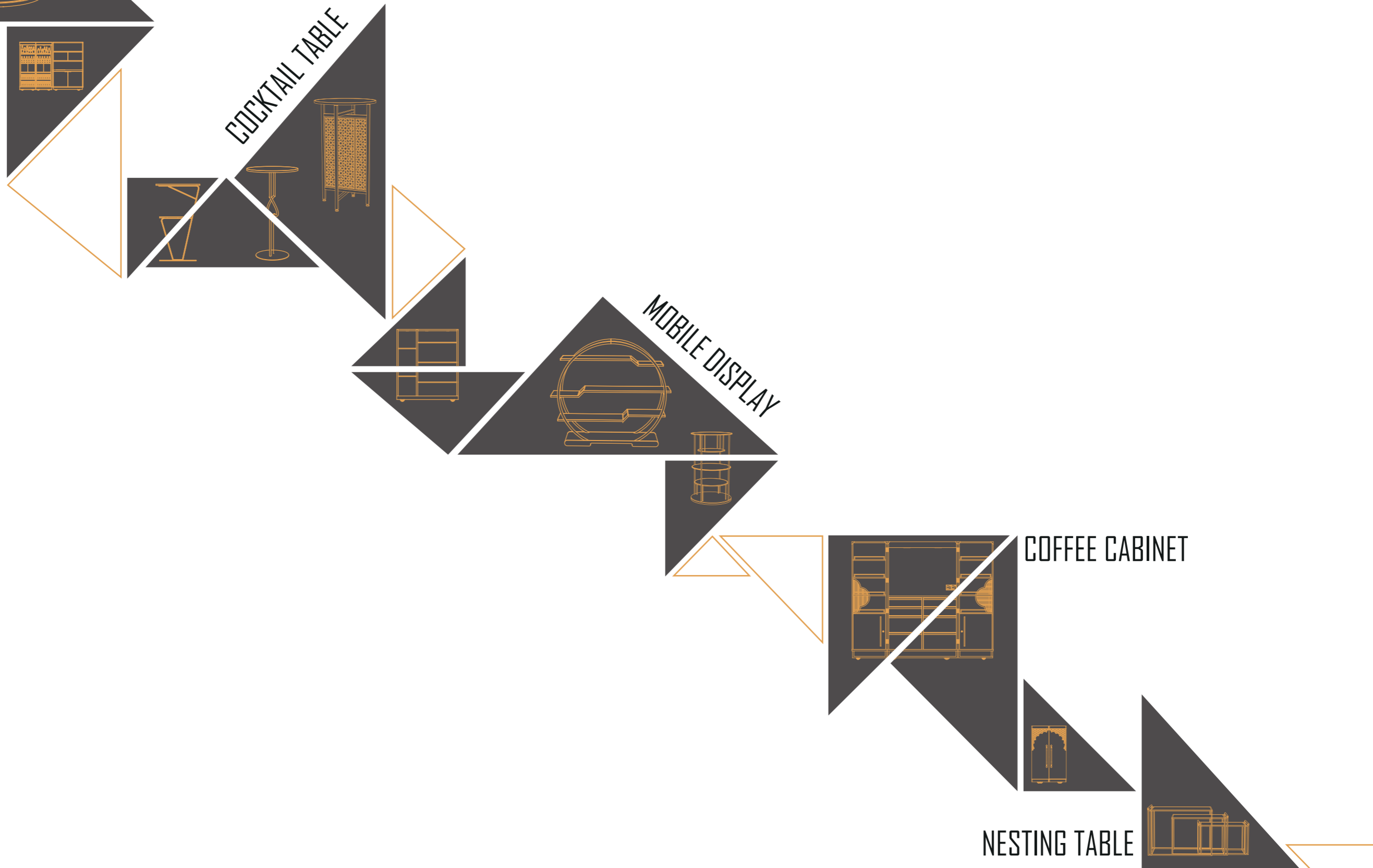

DNA MOBILE BAR SYSTEM

Simple but Powerful

This mobile system free those talented Barista and Bartender for providing professional beverage services everywhere now, indoor/outdoor, from dirty coffee to old fashion.

Combined with quarter bar, straight barside bar and back bar, DNA Mobile Bar System can make this unique working station into many different shapes and sizes. Assembled in minutes by different functional, bars fit almost any settings imaginable.





Setting Up Demonstration



Straight Bar

DNA MOBILE BAR SYSTEM



Setting Up Demonstration



Quarter Bar

DNA MOBILE BAR SYSTEM



Flipping checking door (locking castor)

Accessories



Dry wet depart trash bin

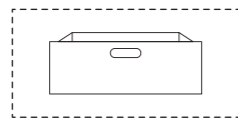

Open storage cabinets (Customized)

Functional Specifications

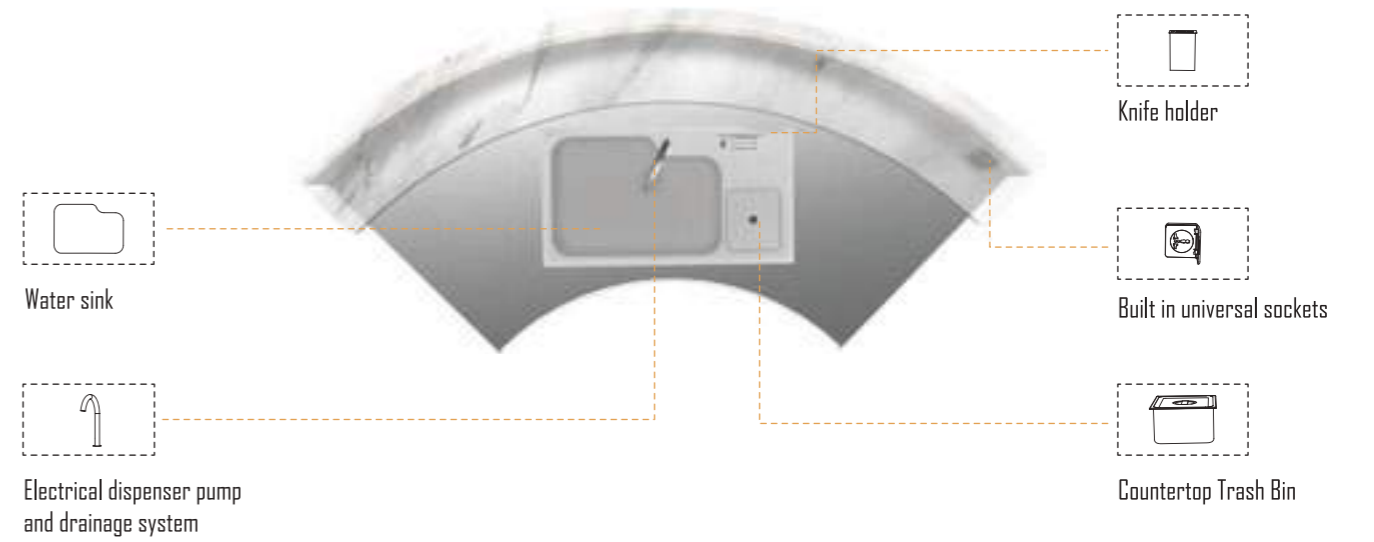

Universal Adaptor



Weatherproof



Dustproof



ELCB adaptor

Straight Bar

DNA MOBILE BAR SYSTEM

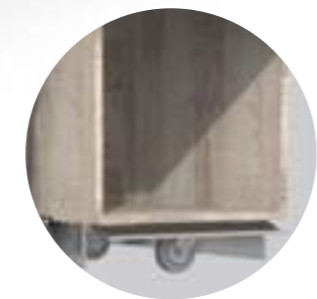

Flipping checking door (locking castor)

Accessories



Speed rails



Dry wet depart trash bin

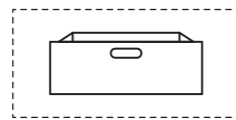

Open storage cabinets (Customized)

Functional Specifications

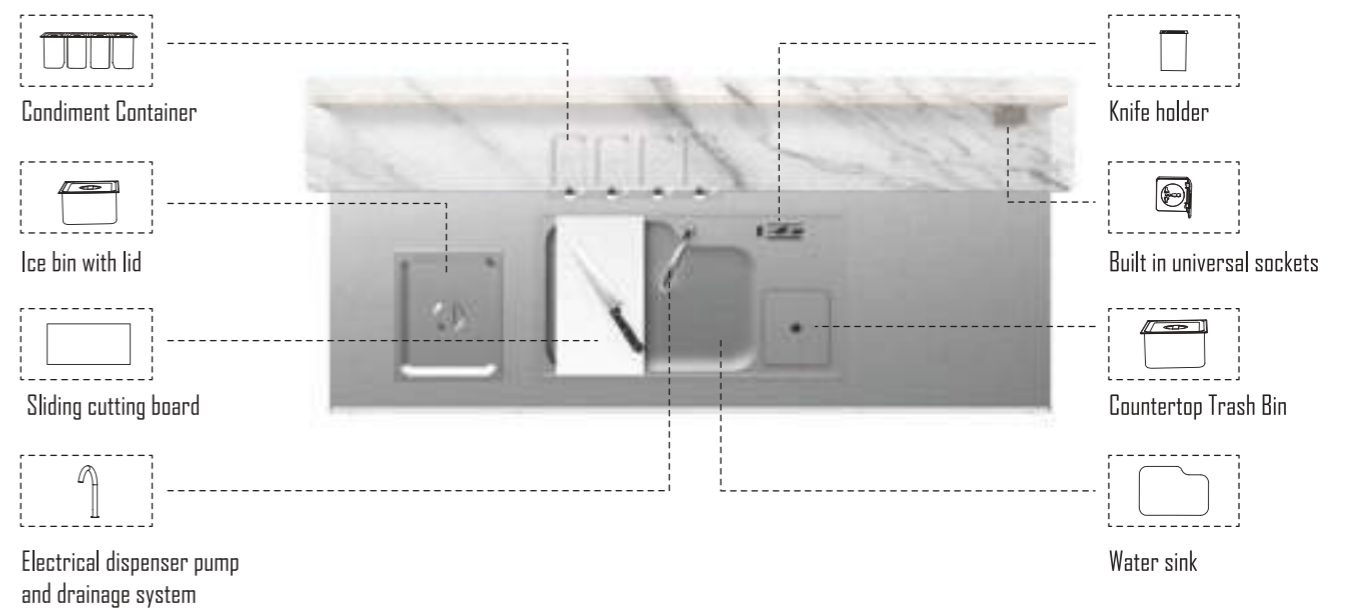

Universal Adaptor



Weatherproof

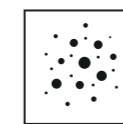

Dustproof



ELCB adaptor



Modular System - T

The modular design offers interchangeable worktops that can create extra space with built-in water sink, dessert display, glass racks and storage room along with the main bars, which empowered the system with additional features besides display shelves. This back bar gives a wider range of drinks for different activities. LED shelves is available for outdoor and night time events.



DNA MOBILE BAR SYSTEM

Modular System - T

M Liquor Cooler Module-M
MT0902



M Ice bin+Liquor cooler Module-M
MT1002



M Hot Plate Module-M
MT0301



M Juice Module-M
MT0802



M Carving Module-M
MT1202



Accessories



Self-sterilizer Cabinet Module



Back Panel

Side Bar

Alongside the main bar, side bar complete this system into a full range of adaptable shapes and styles, also extends the operating space with extra equipment like water sink, ice bin, pre-function area and more. This side bar attach delightful personality to the entire system.

DNA MOBILE BAR SYSTEM



DNA-Side Bar

CODE : BSD10501
SIZE : L800×W800×H850mm



DNA-Water Sink Bar

CODE : BSD10502
SIZE : L800×W800×H850/880mm



DNA-Water Sink Bar

CODE : BSD10503
SIZE : L800×W800×H850mm



DNA-Arcuate Side Bar

CODE : BSD10601
SIZE : L800×W800×H850mm



DNA-Arcuate Clean Side Bar

CODE : BSD10602
SIZE : L800×W800×H850mm



DNA-Arcuate Water Sink Bar

CODE : BSD10603
SIZE : L800×W800×H850/880mm



DNA MOBILE BAR SYSTEM

Simple but Powerful



DNA Mobile Bar Setting Up Demonstration

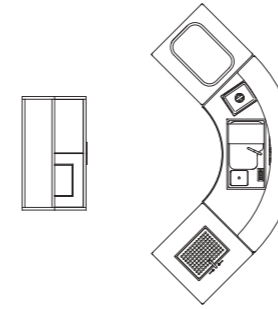

- Quarter Bar × 1
- Back Bar × 1
- Side bar × 2

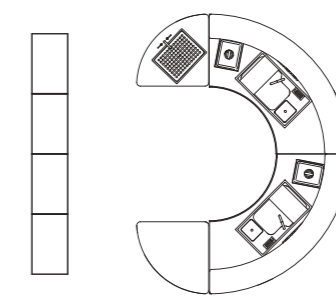

- Quarter Bar × 2
- Back Bar × 2
- Side bar × 2

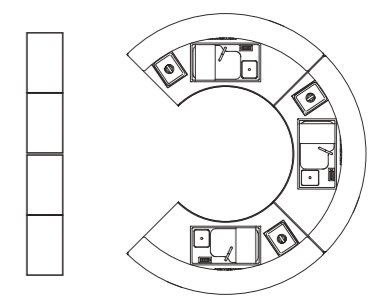

- Quarter Bar × 3
- Back Bar × 2

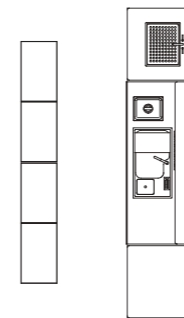

- Straight Bar × 1
- Back Bar × 2
- Side bar × 2

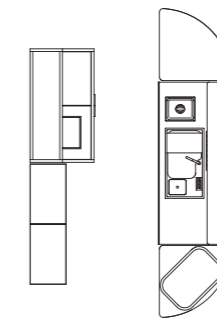

- Straight Bar × 1
- Back Bar × 2
- Side bar × 2

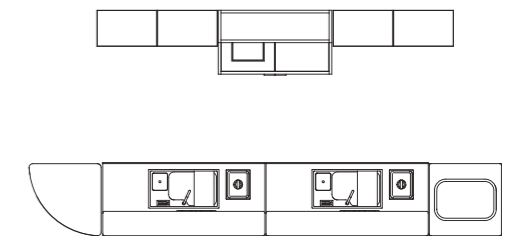

- Straight Bar × 2
- Back Bar × 3
- Side bar × 2

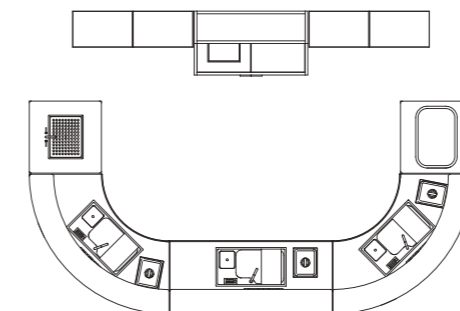

- Quarter Bar × 2
- Straight Bar × 1
- Back Bar × 3
- Side bar × 2

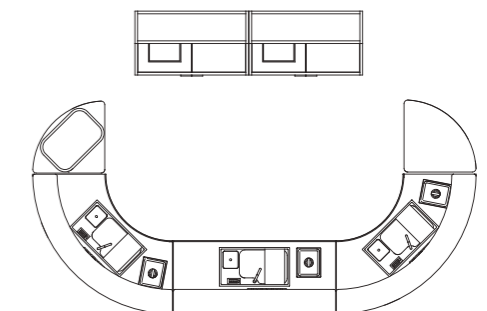

- Quarter Bar × 2
- Straight Bar × 1
- Back Bar × 2
- Side bar × 2



ITEM : DNA-Quarter Bar
CODE : BSD10100
SIZE : L2100 x W1020 x H1150mm



ITEM : DNA-Straight Bar
CODE : BSD10200
SIZE : L1800 x W800 x H1150mm



ITEM : DNA-Module Back Bar
CODE : BSD10400
SIZE : L1260 x W400/800 x H2000mm



ITEM : DNA-Back Bar
CODE : BSD10300
SIZE : L1320 x W400 x H2000mm

COCKTAIL TABLE-FOLDABLE



Cocktail Table 5



CODE : CT1020501

SIZE : D600×H1050mm

CODE : CT1010501

SIZE : D600×H1050mm

Folding Illustration

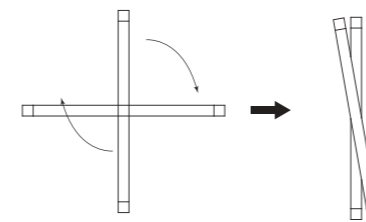

COCKTAIL TABLE



Cocktail table 4

CODE : CT1010401

SIZE : D600×H1050mm

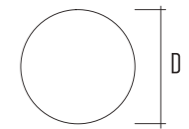
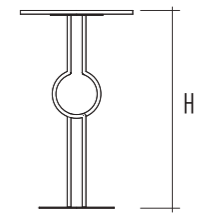

Cocktail table 6

CODE : CT1010601

SIZE : D600×H1050mm

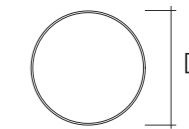
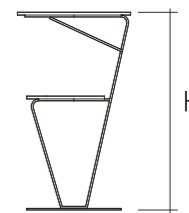

MOBILE DISPLAY



Mobile Display 3

CODE : BDS103

SIZE : L2260×W540×H2000mm

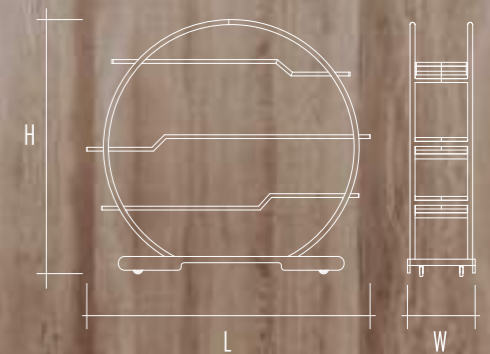

MOBILE DISPLAY



Mobile Display 2

CODE : BDS102

SIZE : L1700×W500×H2000mm

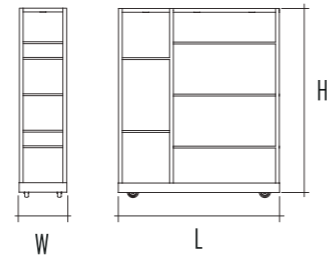

Multi-function Display

CODE : BDS101

SIZE : L1600×W400×H2000mm

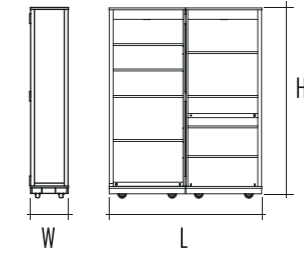

Mobile Display 4

CODE : BDS104

SIZE : D1200×H2000mm

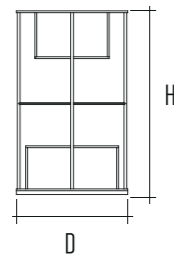

-Roll-up curtain available with customized design

-Half folding for space saving and be suitable for different setting requirement



Stainless steel options



Brushed S/S
SSB



Brushed S/S
Rose Gold Electroplated
SSB-ERG



Brushed S/S
Gold Electroplated
SSB-ERG



Brushed S/S
Black Gold Electroplated
SSB-EBL

Laminate options

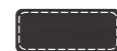

DWN10



FWN11



DWN01

COFFEE CABINET



Design For You

COFFEE CABINET

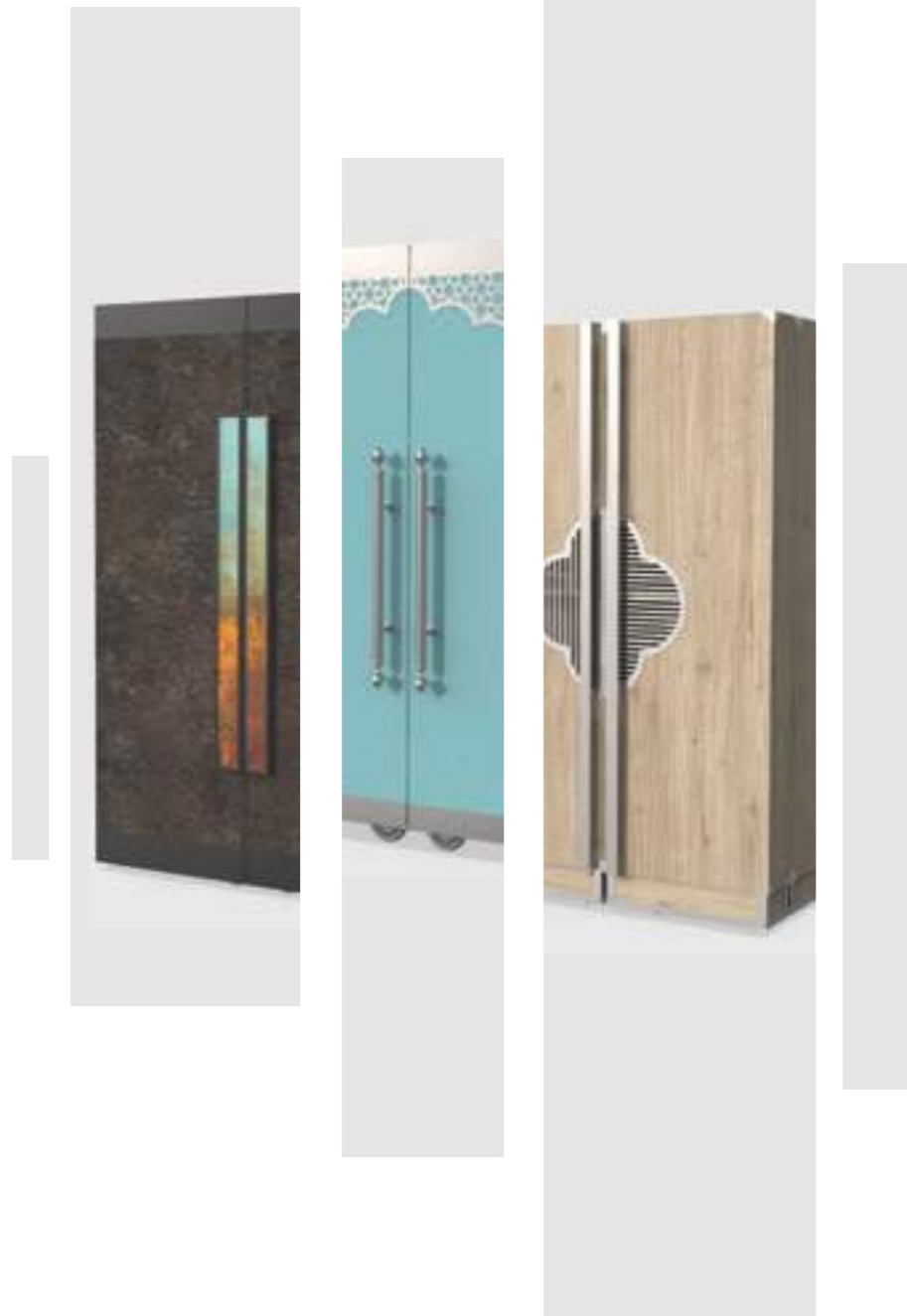

Customized



Handle options

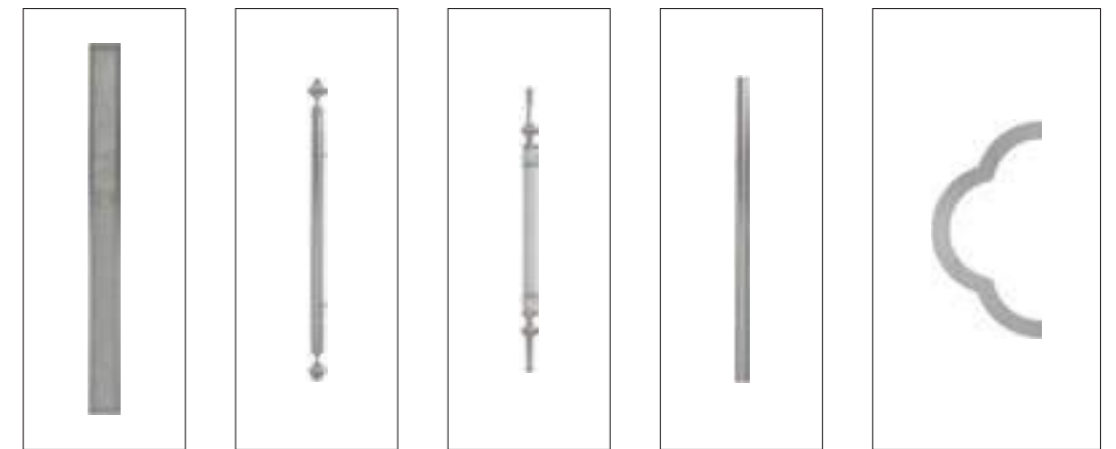

ITEM : Coffee cabinet
 SIZE : L1200×W800×H2000mm

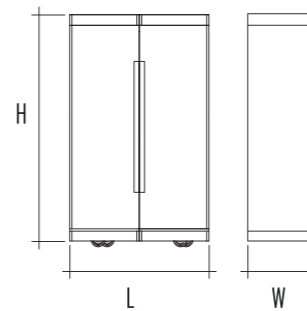

Stainless steel options



Brushed S/S
 SSB



Brushed S/S-Rose Gold Electroplated
 SSB-ERG

Laminate options



DWN10



WWN06



DWN01

COFFEE CABINET

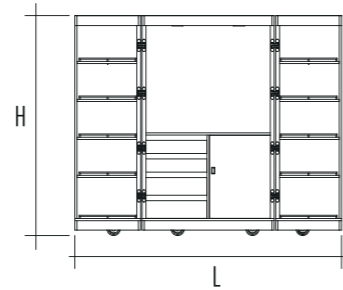

Coffee cabinet 6

ITEM : Coffee cabinet
SIZE : D800×H2000mm

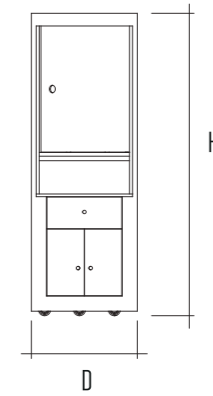

CUSTOMIZED CABINET

OPTIONS	CODE	SIZE	COLLOCATION SHOW
 <p>Drawers</p>	CC001	L1150×W610×H910mm	
 <p>Cabinets+Self-sterilizer Cabinet Modules</p>	CC002	L1150×W610×H910mm	
 <p>Cabinets without door</p>	CC003	L1150×W610×H910mm	

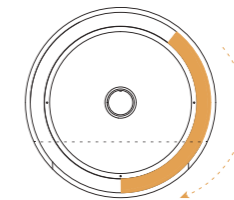

Revolving Design



Universal
Adaptor



Weatherproof

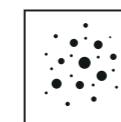

Dustproof



ELCB
adaptor

Stainless steel options



Brushed S/S
SSB



Brushed S/S
Rose Gold Electroplated
SSB-ERG



Brushed S/S
Gold Electroplated
SSB-ERG



Brushed S/S
Black Gold Electroplated
SSB-EBL

Laminate options



DWN10



FWN11



DWN01

NESTING TABLE

Nesting Table I -Rectangle

CODE : NT1040103 SIZE : L1280×W500×H750mm
L1415×W600×H950mm
L1615×W700×H1150mm

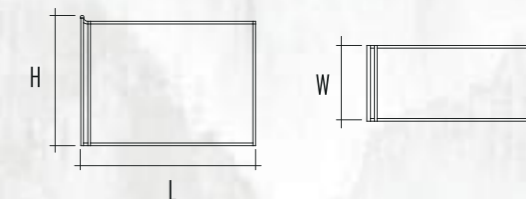

Nesting Table I -Square

CODE : NT1040102 SIZE : L650×W650×H750mm
L750×W750×H950mm
L850×W850×H1150mm

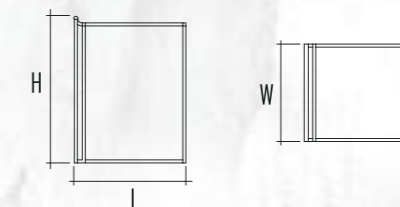

NESTING TABLE

Nesting Table 2-Rectangle

CODE : NT1040201

SIZE : D600×H750mm
D700×H900mm
D800×H1050mm

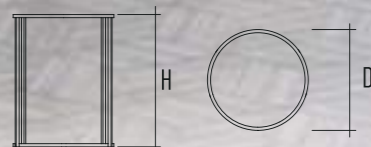

Nesting Table 2-Square

CODE : NT1040202

SIZE : L600×W600×H750mm
L700×W700×H900mm
L800×W800×H1050mm

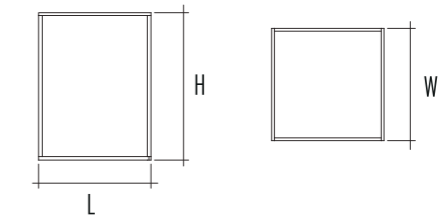

Nesting Table 2-Rectangle

CODE : NT1040203

SIZE : L1100×W580×H750mm
L1300×W620×H900mm
L1500×W660×H1050mm

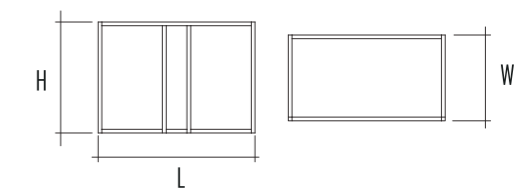

Stainless steel options



Brushed S/S
SSB



Brushed S/S
Rose Gold Electroplated
SSB-ERG



Brushed S/S
Gold Electroplated
SSB-ERG



Brushed S/S
Black Gold Electroplated
SSB-EBL

Laminate options



DWN10



FWN11



DWN01

NESTING TABLE



Nesting Table 3-Square

CODE : NT1040302
SIZE : L600×W600×H750mm
L700×W700×H950mm
L800×W800×H1150mm



Nesting Table 3-Rectangle

CODE : NT1040303
SIZE : L600×W600×H750mm
L700×W700×H950mm
L800×W800×H1150mm

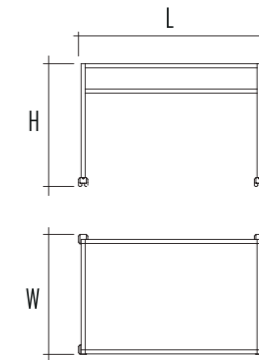

Nesting Table 3-Round

CODE : NT1040301
SIZE : Ø600×H750mm
Ø800×H950mm
Ø1000×H1150mm

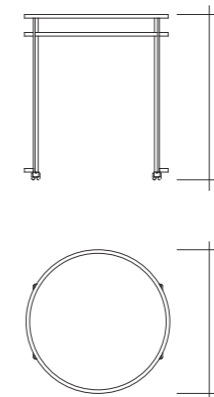

FOLDING BUFFET TABLE



Folding Demonstration

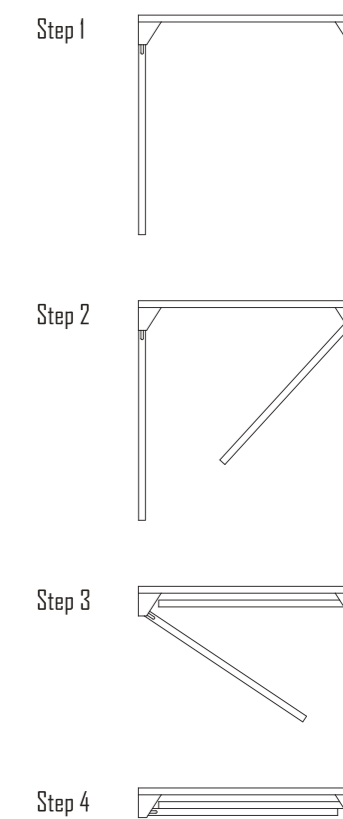

Folding Buffet Table-Rectangle

CODE : BT1040003 SIZE : L1100×W700×H750mm
 L1300×W700×H950mm
 L1500×W700×H1150mm

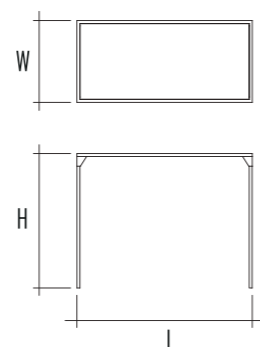

Folding Buffet Table-Square

CODE : BT1040002 SIZE : L800×W800×H750mm
 L1000×W1000×H950mm
 L1200×W1200×H1150mm

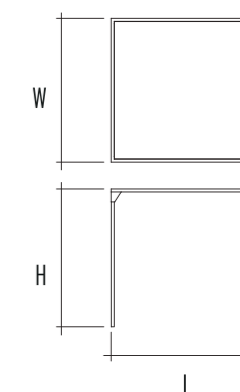

SERVICE TROLLEY

Unix-M



Cubix-M

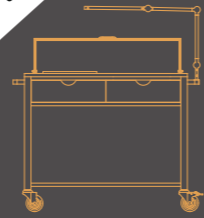

Luna-M

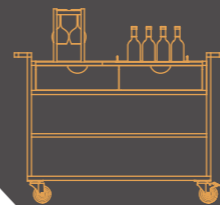

Luxe-M



Cosmo-M



ONE SERVICE TROLLEY SYSTEM

Service Trolley is underrated. TC face the challenge by re-formulating trolley's role in F&B operation. This versatile trolley is not used only as a food and wine display but can be converted to many other usages such as a mini bar to food warmer. With our Module System-T design, ONE trolley diversified into a multipurpose cart.

ONE SERVICE TROLLEY SYSTEM

Service Trolley is underrated.

TC face the challenge by re-formulating trolley's role in F&B operation. This versatile trolley is not used only as a food and wine display but can be converted to many other usages such as a mini bar to food warmer. With our *Module System-T* design, ONE trolley diversified into a multipurpose cart.



ONE SERVICE TROLLEY SYSTEM

Cosmo-M

Stainless steel options

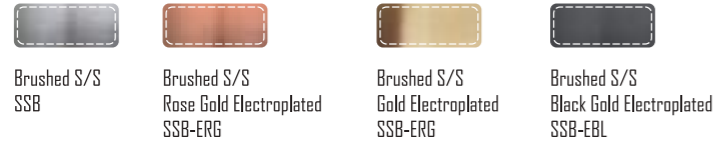

Laminate options



Cosmo-Carving Trolley
STM100403



Cosmo-Dessert Trolley
STM100203



Cosmo-Ice Display Trolley
STM101102



Cosmo-Liquor Trolley
STM101002



Plain Trolley

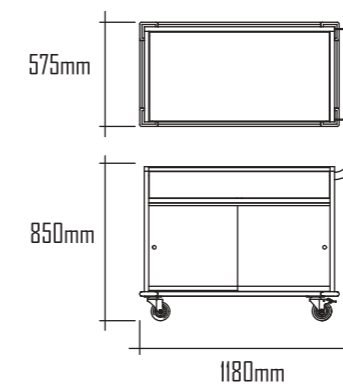

Luxe-Tea Trolley
STM110702



Luxe-Liquor Trolley
STM111002



Stainless steel options



Brushed S/S
SSB

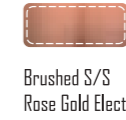

Brushed S/S
Rose Gold Electroplated
SSB-ERG



Brushed S/S
Gold Electroplated
SSB-ERG



Brushed S/S
Black Gold Electroplated
SSB-EBL

Laminate options



DWNID



FWNII



DWNDI

Luxe-Ice Display Trolley
STM111102



Luxe-Hot Plate Trolley
STM110302



Plain Trolley

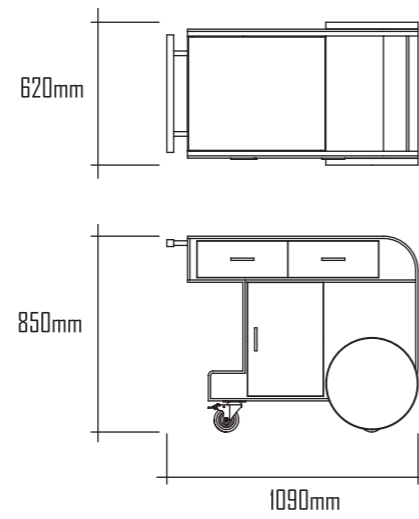

Unix-M

Unix-Carving Trolley
STM051202



Plain Trolley

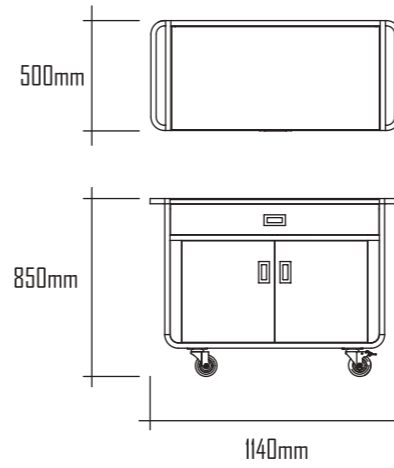

Unix-BBQ Trolley
STM051501



Unix- Liquor Trolley
STM051002



Unix-Dessert Trolley
STM050203



Stainless steel options



Laminate options



Luna-M



Plain Trolley

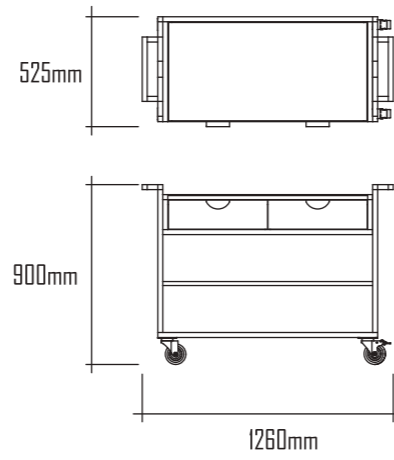

Luna-Carving Trolley
STM070403



Luna-BBQ Trolley
STM071501



Luna-Ice Display Trolley
STM071102

Luna-Display Trolley
STM071601



Stainless steel options



Laminate options



Cubix-M

Stainless steel options



Brushed S/S
SSB



Brushed S/S
Rose Gold Electroplated
SSB-ERG



Brushed S/S
Gold Electroplated
SSB-ERG



Brushed S/S
Black Gold Electroplated
SSB-EBL

Laminate options



DWNID



FWNII



DWNDI

Cubix-Hot Plate Trolley
STM060302



Cubix-Cooking Trolley
STM061301



Cubix-Tea Trolley
STM060702



Cubix-Juice Trolley
STM060802



Plain Trolley

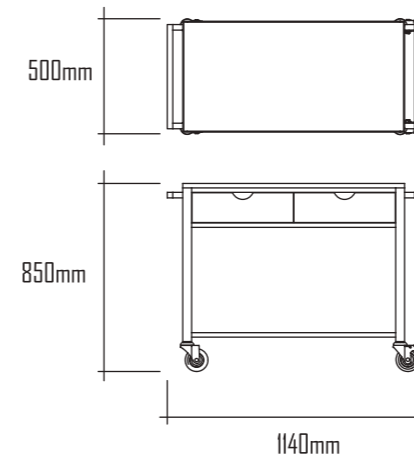

Modular System-T



- S

L400×W500mm
L15.7"×W19.7"
- M





L600×W500mm
L23.6"×W19.7"
- L

L1000×W500mm
L39.4"×W19.7"

- | | | | |
|---|---|--|---|
| <div style="border: 1px solid black; padding: 2px; width: 15px; margin: 0 auto;">M</div> <p>Liquor Cooler Module-M
MT0902</p>  | <div style="border: 1px solid black; padding: 2px; width: 15px; margin: 0 auto;">M</div> <p>Ice bin+Liquor cooler Module-M
MT1002</p>  | <div style="border: 1px solid black; padding: 2px; width: 15px; margin: 0 auto;">M</div> <p>Cassette holder Module-S
MT1302</p>  | <div style="border: 1px solid black; padding: 2px; width: 15px; margin: 0 auto;">M</div> <p>Hot Plate Module-M
MT0301</p>  |
| <div style="border: 1px solid black; padding: 2px; width: 15px; margin: 0 auto;">M</div> <p>Juice Module-M
MT0802</p>  | <div style="border: 1px solid black; padding: 2px; width: 15px; margin: 0 auto;">M</div> <p>Tea Module-M
MT0702</p>  | <div style="border: 1px solid black; padding: 2px; width: 15px; margin: 0 auto;">M</div> <p>Carving Module-M
MT1202</p>  | <div style="border: 1px solid black; padding: 2px; width: 15px; margin: 0 auto;">M</div> <p>Ice Display Module-M
MT1102</p>  |

- | | | | |
|---|--|---|--|
| <div style="border: 1px solid black; padding: 2px; width: 15px; margin: 0 auto;">S</div> <p>Plain Module-L
MT0103</p>  | <div style="border: 1px solid black; padding: 2px; width: 15px; margin: 0 auto;">L</div> <p>Carving+Hot Plate Module-L
(with cover)
MT0401</p>  | <div style="border: 1px solid black; padding: 2px; width: 15px; margin: 0 auto;">L</div> <p>Dessert Module-L
MT0201</p>  | <div style="border: 1px solid black; padding: 2px; width: 15px; margin: 0 auto;">L</div> <p>Sneeze Guard Module-L
MT0501</p>  |
|---|--|---|--|

Accessories

- | | | | |
|---|--|--|---|
| <div style="border: 1px solid black; padding: 2px; width: 15px; margin: 0 auto;">S</div> <p>Square Rack Module-S
MT1602</p>  | <div style="border: 1px solid black; padding: 2px; width: 15px; margin: 0 auto;">S</div> <p>Glass Rack Module-S
MT1402</p>  | <p>Oval Rack Module-S
MT1702</p>  | <div style="border: 1px solid black; padding: 2px; width: 15px; margin: 0 auto;">S</div> <p>BBQ Module-M
MT1502</p>  |
| <p>Stainless Steel Box
MT1802</p>  | | | |

R O O M

ROOM SERVICE TROLLEY

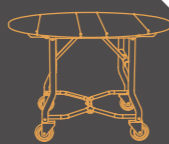

VINCENT TROLLEY

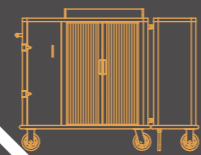

TERSE M

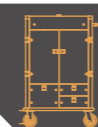

SMART TROLLEY



ALPHA E



ALPHA L-M



ALPHA S-M



ALPHA S



ALPHA L



ALPHA HOUSEKEEPING SYSTEM

This system aims to improve efficiency and manage the internal logistic challenges in housekeeping operation. It includes Alpha HK cart, Auxil cart and BOH station. With optimal storage spaces design, Alpha can load all house keeping essentials: bedding, linen, vacuum, amenities, glasses, garbage can, cleaning tools etc. Auxil cart is preloaded with a rechargable battery and automatic following system to follow Alpha cart for material supplies. BOH Station is used for storing all marterials in ToGo drawers, those modular drawers is designed to aim fast loading, effort saving and easy organization.

ALPHA HOUSEKEEPING SYSTEM

This system aims to improve efficiency and manage the internal logistic challenges in housekeeping operation. It includes Alpha HK cart, Auxi cart and BOH station. With optimal storage spaces design, Alpha can load all house keeping essentials: bedding, linen, vacuum, amenities, glasses, garbage can, cleaning tools etc. Auxi cart is preloaded with a rechargeable battery and automatic following system to follow Alpha cart for material supplies. BOH Station is used for storing all materials in ToGo drawers, those modular drawers is designed to aim fast loading, effort saving and easy organization.



Alpha L-M



Alpha S-M



Alpha L



Alpha E

Alpha L

HTADIL

Size: 1930/1590 × W510 × H1200mm

ALPHA HOUSEKEEPING SYSTEM

For maximum space advantage, we designed the special range of compartments on top of a drawer in Alpha cart for amenities with a roll-up door. Standard 3 shelves are perfect for clean linens. Dirty linens go to one side of the removable waterproof linen bag. Another side is a smaller bag which can be used for collecting garbage, beneath space for vacuum or other cleaning equipment. And last but not least a rack holder is installed at bottom of the cart to store glasses and cups.



ALPHA HOUSEKEEPING SYSTEM

Alpha L

HTADIL

Size: 1930/1590×W510×H1200mm



Anodized Aluminum Options



Anodized Aluminum Silver
AL-SOI

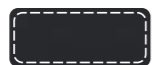

Anodized Aluminum Black
AL-BLKDG

Laminate options



DWNID



WWNOG



DWNDI

Accessories



Top Roll-up Door

Linen Bag L



Linen Bag S



9 Pockets Bag



Map Clips

Under-Deck
Glass Holder Rack



Main technical parameters

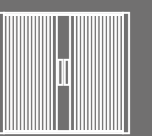

Shutter Roller Doors

ROOMS

Outlets

300kg

Loading Capacity



6" Castors



2 Swivel Castors
With Brakes



3 Layers

Alpha S

HTADIS

Size: L410×W430×H1190mm

ALPHA HOUSEKEEPING SYSTEM

Alpha S is made for discreet tasks such like turn-down service. This compact cart is easily be pushed into the room, making service invisible to the guest.



Accessories



Roll-Up Door

ROOMS

Outlets

290kg

Loading Capacity



6" Castors



2 Swivel Castors
With Brakes



2 Layers

Alpha L - M

HTAMDIL

Size: L930/1590×W510×H1200mm

ALPHA HOUSEKEEPING SYSTEM

Modular Design

This modular system works between Alpha-M, Auxi and BOH station. It benefits in fast loading, repair and exchange, instead of reloading the entire cart, change single module is more convenient and effort saving.



ALPHA HOUSEKEEPING SYSTEM

Alpha L - M

HTAMDIL

Size: L930/1590 x W510 x H1200mm



ROOMS

Outlets

300kg

Loading Capacity



6" Castors



2 Swivel Castors
With Brakes

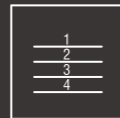

3 Layers

Accessories



Top Roll-Up
Door

Map Clips



Under-Deck
Glass Holder
Rack



Linen Bag L



Linen Bag S

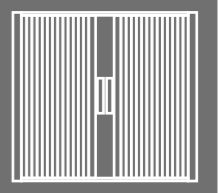

Shutter Roller
Doors

ToGo Drawer-L1

ToGo Drawer-L2

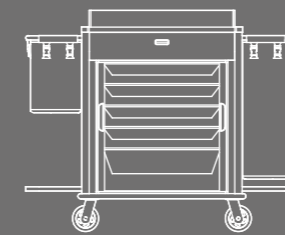

ALPHA L-M

HTAMDIL

L930/1590 x W510 x H1200mm

Alpha S - M

HTAMD1S

Size: L480×W500×H1290mm

ALPHA HOUSEKEEPING SYSTEM

Accessories



Roll-Up Door

ToGo Drawer-S2

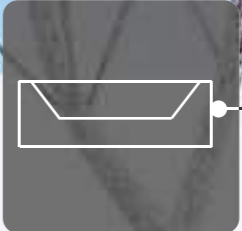

ToGo Drawer-S1



ALPHA S-M CXQ37VCM

L480×W500×H1290mm

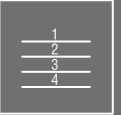
 <p>ROOMS Outlets</p>	 <p>290kg Loading Capacity</p>	 <p>6" Castors</p>	 <p>2 Swivel Castors With Brakes</p>	 <p>3 Layers</p>
--	---	---	---	---



Alpha - M Auxi

HTAMA01

Size: 1870xW540xH1570mm

As a partner of Alpha, Auxi was designed with big loading capacity for linen, amenities, drinks etc. Usually loaded carts are heavy to push, but we empower the Auxi cart with a rechargeable battery, electric wheel with brakes and a automatic following system. Auxi follow Alpha without pushing, that drives logistic and operational efficiency up and save efforts. As a result, Auxi make housekeeping as easy as possible.



ALPHA HOUSEKEEPING SYSTEM

Accessories

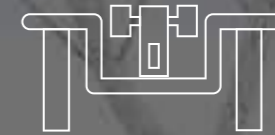

Joystick

ToGo Drawer-L2

ToGo Drawer-L1

ROOMS

Outlets

330kg

Loading Capacity



8" Castors



2 Swivel Castors
With Brakes

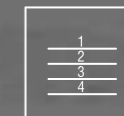



5 Layers

ToGo Drawer

Standardized ToGo Drawer modules is available in 4 sizes, you can customize the storage space by playing with those drawer modules to meet your specific request. ToGo Drawer is exchangeable between Alpha cart, Auxi cart and BOH station, that enables fast pre-loading, fast replenishment for saving operation time.



- 

CODE : HTAMDLI
SIZE : L720×W400×H115mm
- 

CODE : HTAMD L2
SIZE : L720×W400×H240mm



ALPHA HOUSEKEEPING SYSTEM

- 

CODE : HTAMDS1
SIZE : L360×W400×H115mm

- 

CODE : HTAMDS2
SIZE : L360×W400×H240mm

BOH Station
CODE : HTAMBO1
SIZE : L1550×W500×H2000mm

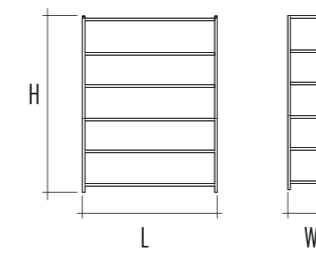

Alpha E

HTAEDIL

Size: L1590×W510×H1320mm

ALPHA HOUSEKEEPING SYSTEM



Shaving kit



Comb



Nurse kit



Amenities



Mouthwash



Slipper



Toilet rolls



Toilet rolls



Hair Dryer



USB cable



Vacuum cleaners



Broom



Sorting/Sanitary Bins



Soiled Linens



Mineral water

Accessories

Joystick



Linen Bag L



Top Roll-up Door



Shutter doors

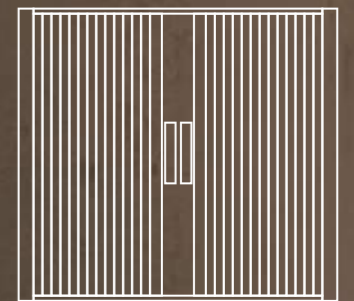

Heavy Duty Deck With Electric Castors

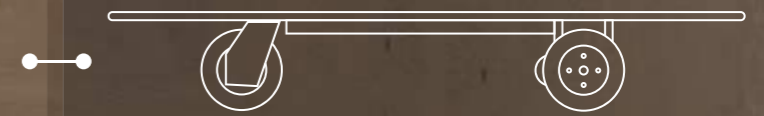

-Safety Design. Fully locking stop without pushing.
-Stable and controllable speed.

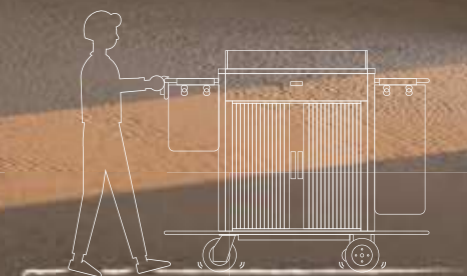

Alpha E

HTAEOIL

Size: L1590×W510×H1320mm



ALPHA HOUSEKEEPING SYSTEM

- Electric wheels with rechargeable battery and speed control
- Stable and energy-efficient driving method
- Large capacity , special designed with large capacity to handle heavy loads

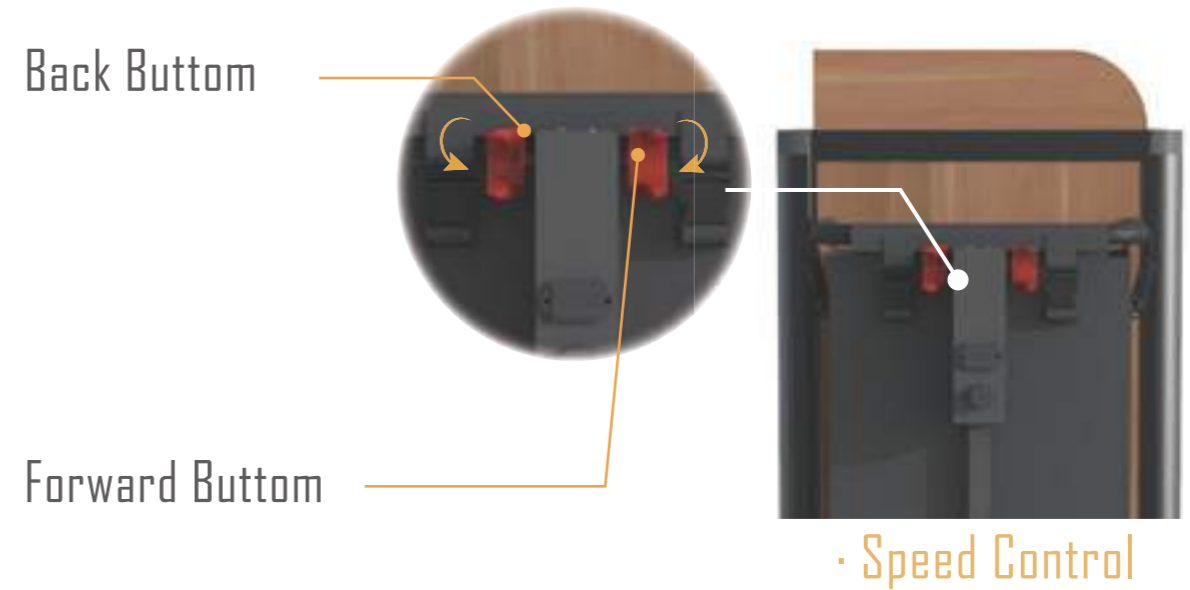



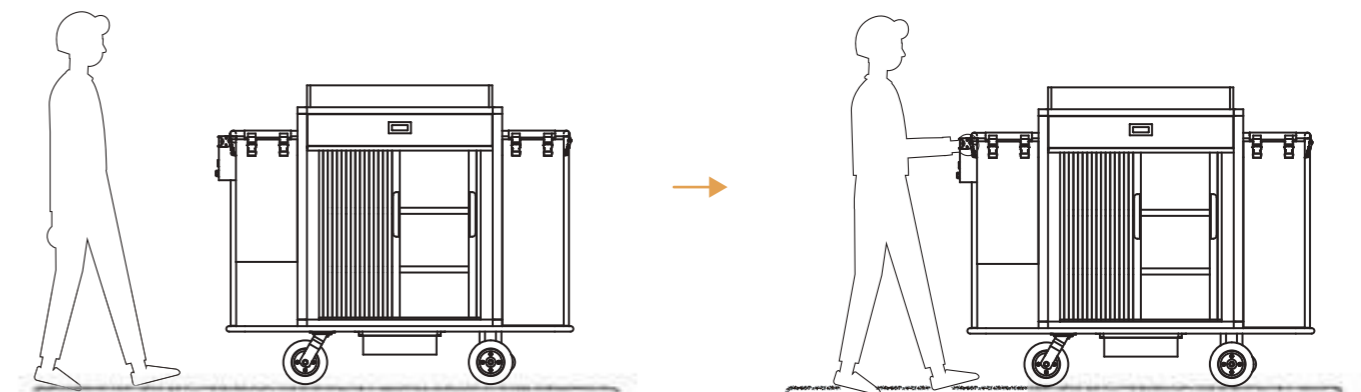



Automatically Stop When No Pushing





ALPHA HOUSEKEEPING SYSTEM

Accessories

	ITEM	APPLICABLE TROLLEY	
	Top Roll-Up Door	Alpha L Alpha L-M	
	Roll-Up Door	Alpha L Alpha L-M Alpha E	
	Shutter Roller Doors	Alpha S Alpha S-M	
	Under-Deck Glass Holder Rack	Alpha L Alpha L-M	
	Linen Bag L	Alpha L Alpha L-M Alpha E	
	Linen Bag S	Alpha L Alpha L-M Alpha E	
	9 Pockets Bag	Alpha L Alpha L-M Alpha E	Smart Trolley
	Mop Clips	Alpha L Alpha L-M Alpha E	Smart Trolley

HOUSEKEEPING TROLLEY



Smart Trolley



Terse M



Vincent Trolley

HOUSEKEEPING TROLLEY

Terse M

Just Like a Cabinet

Fully covered design makes Terse looks like a cabinet. Optimized storage design offers Terse unbelievable loading capacity.



CXQ41A2

L830×W500×H1270mm

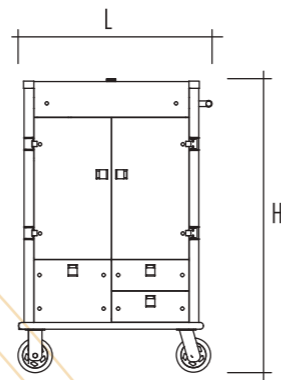

Smart Trolley

Great Value

Powder coating frame is wear and tear resistant for longterm use. Integrated structure, heavy duty capacity and easy to clean.



HT0020

L1580×W500×H1420mm

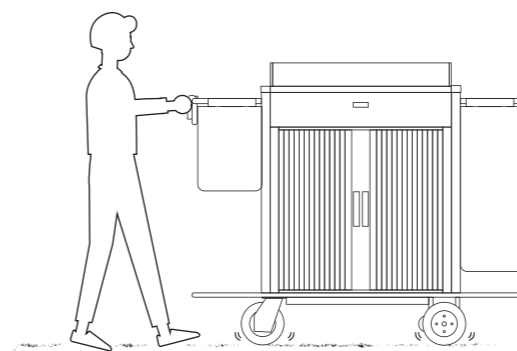
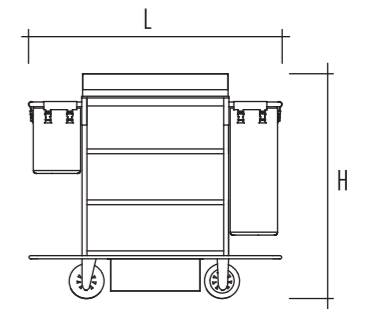

HOUSEKEEPING TROLLEY

Vincent Trolley

The biggest loader trolley would be Vincent. It comes with a detachable storage bin that has two(2) built in wheels. It can free stand on its own or be hooked on to the trolley for additional storage. Vincent is one of our most versatile cart in this collection.



Vincent Trolley L&S HTVOILS

L1570×W650×H1160mm

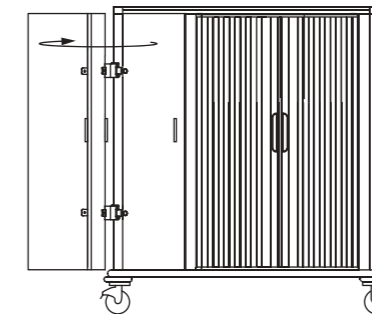

270° Pull-out door

The doors can be fully opened to fit the body. Don't keep out the line of sight, save space and don't interfere with work.



Vincent Trolley L HTVOIL

L1150×W650×H1160mm



Vincent Trolley S HTVOIS

L420×W650×H1160mm

ROOM SERVICE TROLLEY

Foldable and stacking design, easy storage and transportation.



Tri-folded Room Service Trolley R020100
L1050×W900×H765mm

Five-folded Room Service Trolley R020200
L1085×W915×H750mm

With charging Units



Hot Box Rack RAC0302
L1120×W450×H1510mm

Hot Box R030000
L350×W380×H492mm

Hot Box Rack RAC0301
L1650×W450×H1815mm

Hot Box R030000
L350×W380×H492mm

LINEN CART

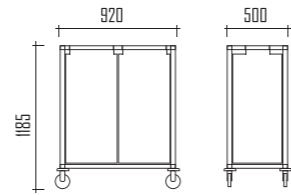

CXQ42A1

- SIZE:**
L920×W500×H1185mm
- STANDARD EQUIPMENT:**
Anodized aluminum frame
4 Impact absorbing and non-marring bumpers
- OPTIONAL EQUIPMENT:**
2 Detachable water proof oxford linen bags (2 colours)
- CASTORS:**
4 quiet heavy duty wheels

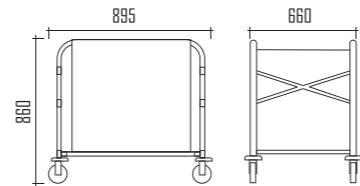

CXQXC300

- SIZE:**
L895×W660×H860mm
- STANDARD EQUIPMENT:**
Anodized aluminum frame
4 Impact absorbing and non-marring bumpers
- OPTIONAL EQUIPMENT:**
1 Detachable water proof oxford linen bag
- CASTORS:**
4 quiet heavy duty wheels

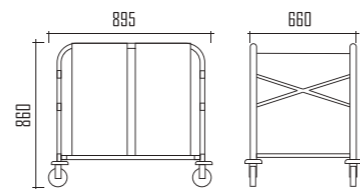

CXQXC300M

- SIZE:**
L895×W660×H860mm
- STANDARD EQUIPMENT:**
Anodized aluminum frame
4 Impact absorbing and non-marring bumpers
- OPTIONAL EQUIPMENT:**
2 Detachable water proof oxford linen bags (2 colours)
- CASTORS:**
4 quiet heavy duty wheels

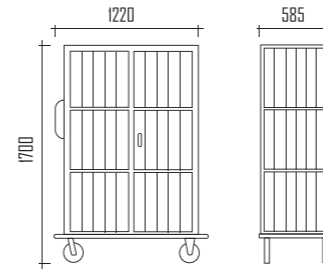

CXQ37K1-I

- SIZE:**
L1220×W585×H1700mm
- STANDARD EQUIPMENT:**
Metal frame, anti-rust powder coated finish
2 powder coating steel shelves
Rubber bumper
- OPTIONAL EQUIPMENT:**
Pull-out door with/without lock
- CASTORS:**
4 quiet heavy duty 6" wheels



CXQ37K2

- SIZE:**
L1360×W760×H1730mm
- STANDARD EQUIPMENT:**
Metal frame, anti-rust powder coated finish
2 powder coating steel shelves
Rubber bumper
- CASTORS:**
4 quiet heavy duty 6" wheels



F R O N T
H O U S E

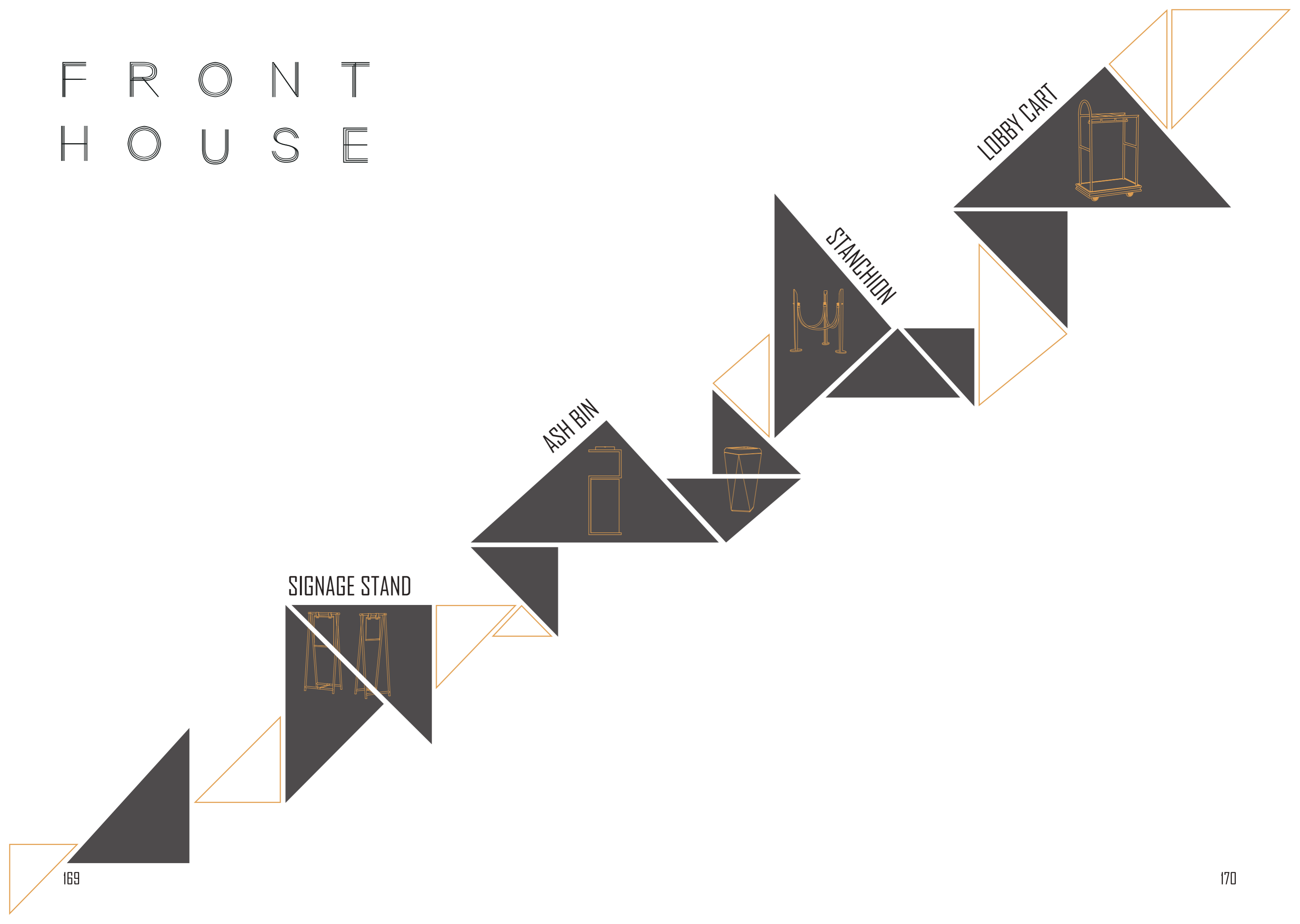

ASH BIN

STANCHION

LOBBY CART

SIGNAGE STAND

LOBBY CART



Stainless Steel Options



Brushed #304 SIS
SSB



Mirrored #304 SIS
SSM



Brushed SS-Gold
Electroplated
SSB-EG



Mirrored SS-Gold
Electroplated
SSM-EG



Brushed SS-Rose
Gold Electroplated
SSB-ER



Mirrored SS-Rose
Gold Electroplated
SSM-ER

Carpet Options



Black



Claret



Blue



Brown



Purple



Green



Grey

LOBBY CART

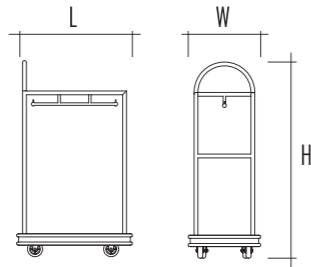

CODE : LBCD10103
SIZE : L1120×W600×H1830mm
FRAME : #304 stainless steel frame, brush finishing
BUMPER : Black rubber
DECK : Carpet with colour option
CASTORS : 4 quiet heavy duty rubber 6" castors

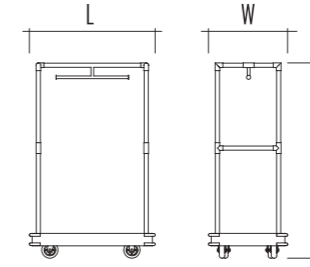

CODE : LBCD10106
SIZE : L1110×W680×H1800mm
FRAME : #304 stainless steel frame, brush finishing
BUMPER : Black rubber
DECK : Carpet with colour option
CASTORS : 4 quiet heavy duty rubber 6" castors

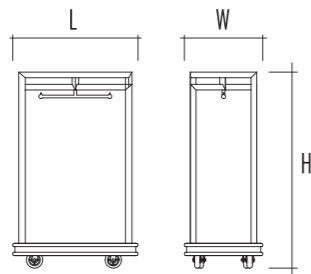

CODE : LBCD10105
SIZE : L1110×W680×H1800mm
FRAME : #304 stainless steel frame, brush finishing
BUMPER : Black rubber
DECK : Carpet with colour option
CASTORS : 4 quiet heavy duty rubber 6" castors

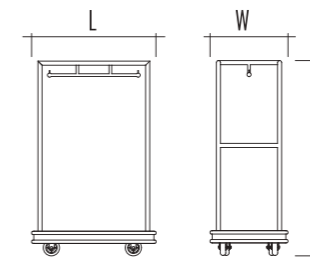

CODE : LBCD10101
SIZE : L1150×W720×H1840mm
FRAME : #304 stainless steel frame, brush finishing
BUMPER : Black rubber
DECK : Carpet with colour option
CASTORS : 4 quiet heavy duty rubber 6" castors

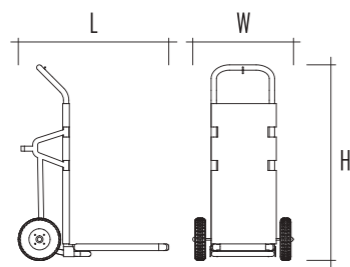

CODE : LGCD10102
SIZE : L870×W530×H1200mm
FRAME : Foldable #304 Stainless steel frame, brush finishing
BUMPER : Black rubber
DECK : Carpet with colour option
CASTORS : 2 quiet heavy duty 10" pneumatic castors

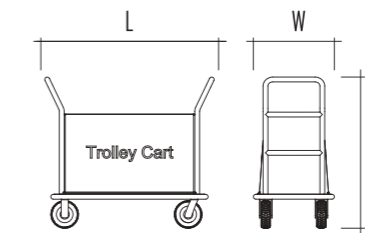

CODE : LGCD10201-I
SIZE : L1300×W670×H960m
FRAME : #304 stainless steel frame, brush finishing
BUMPER : Black rubber
DECK : Carpet with colour option
CASTORS : 4 quiet heavy duty 8" pneumatic castors

STANCHION

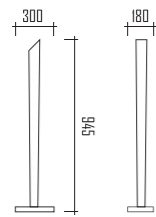

SCO10101

SIZE :
L300×W180×H945mm
STRUCTURE :
#304 stainless steel, brush finishing

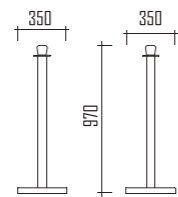

SCO10102

SIZE :
∅ 300×H900mm
STRUCTURE :
#304 stainless steel, brush finishing

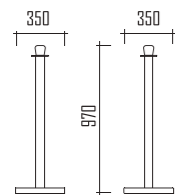

SCO10201

SIZE :
L340×W290×H950mm
STRUCTURE :
#304 stainless steel, mirror finishing



SCO50101

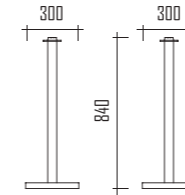

SIZE :
L300×W300×H840mm
STRUCTURE :
Brass, brush finishing



SCO10103

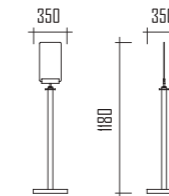

SIZE :
L350×W350×H1180mm
STRUCTURE :
#304 stainless steel, brush finishing



SCO10104

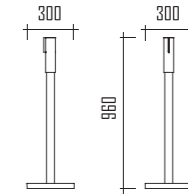

SIZE :
L300×W300×H960mm
STRUCTURE :
#304 stainless steel, brush finishing



RPO10101

ITEM : Stanchion Rope
SIZE : L180mm



ASH BIN



ASH BIN



AB010105

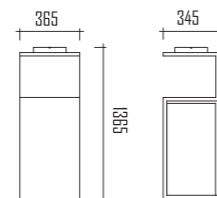

SIZE : L365×W345×H1365mm
 TOP AND FRAME: #304 stainless steel, brush finishing



Touch free sanitizer dispenser



Wipe dispenser



Trash can build in to dispose used wipe immediately



AB030101

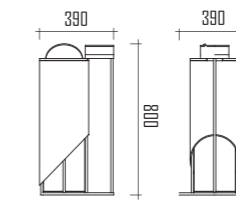

SIZE : L390×W390×H800mm
 TOP AND FRAME: #304 Stainless steel, electroplated finishing

AB050101

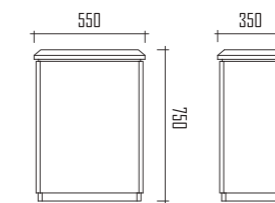

SIZE : L550×W350×H750mm
 TOP AND FRAME : Brass frame, brush finishing
 BODY : Marble



AB010101

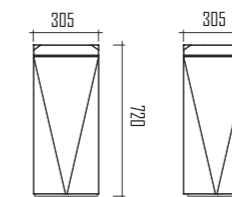

SIZE : L305×W305×H720mm
 TOP AND FRAME: #304 stainless steel frame, brush finishing
 BODY : Marble

SIGNAGE STAND



BXQ6E1

Size : L540/640×W450×H1510mm
 Frame :
 Brushed #304 stainless steel
 Board Size : A4 A3

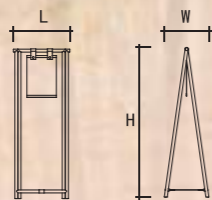

SS080001

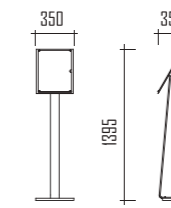

SIZE : L350×W350×H1395mm
 FRAME : Anodized aluminum alloy frame
 BOARD SIZE : 360° Rotating A3 size

SS010106

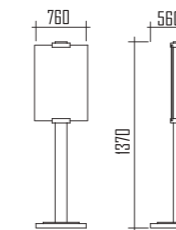

SIZE : L700×W450×H1630mm
 FRAME :
 #304 stainless steel frame, brush finishing
 BOARD SIZE : A3 size



SS010101

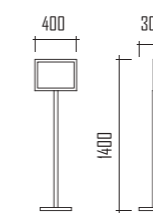

SIZE : L400×W300×H1400mm
 FRAME :
 #304 stainless steel frame, brush finishing
 BOARD SIZE : A3 size

BANQUET

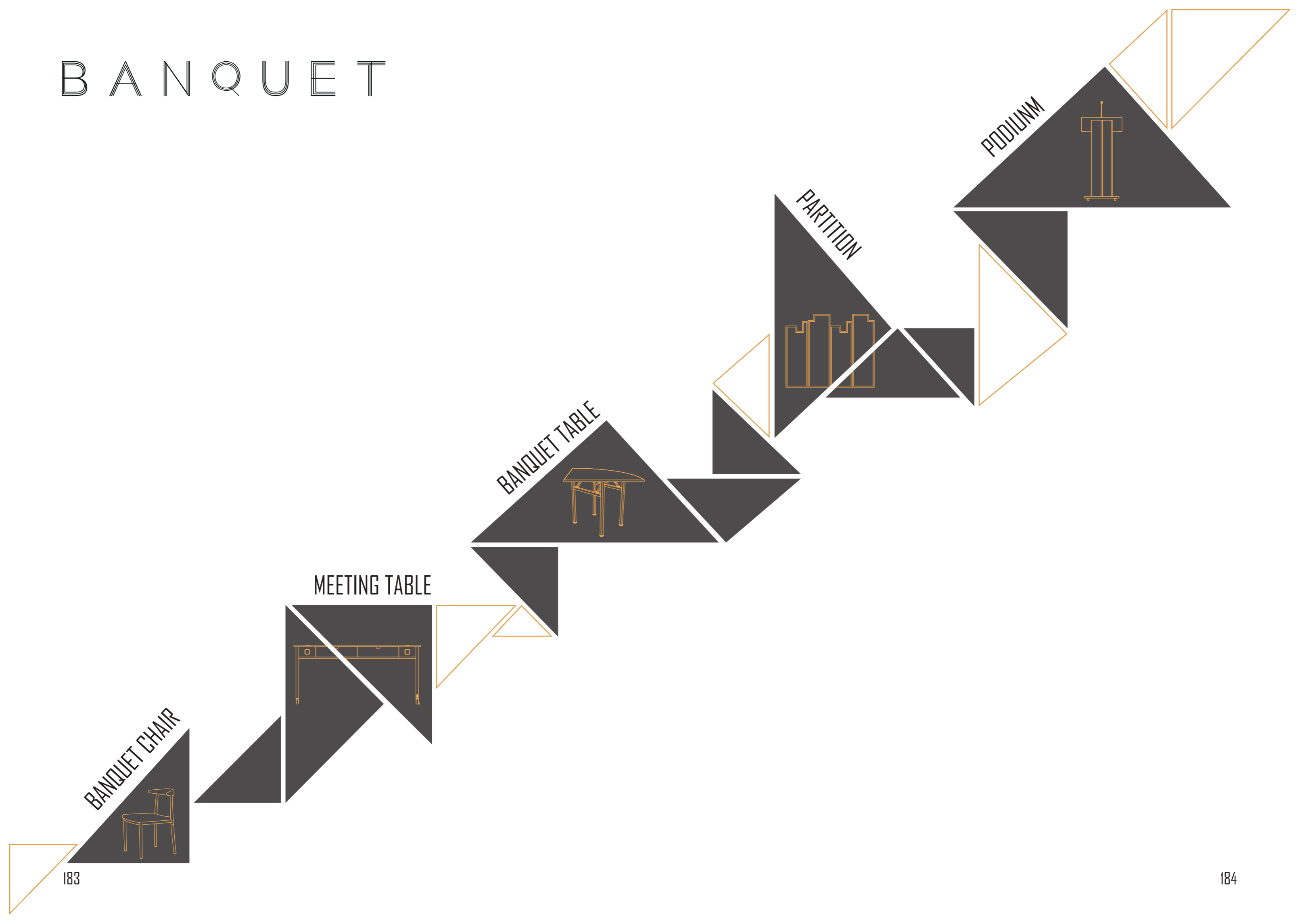

BANQUET CHAIR



MEETING TABLE

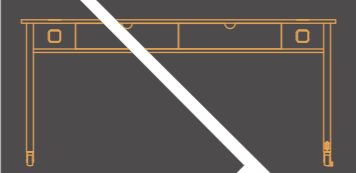

BANQUET TABLE

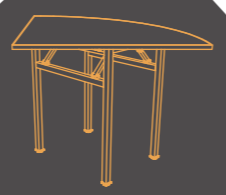

PARTITION

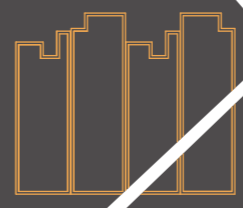

PODIUM





OUTDOOR BANQUET CHAIR

Code:BC0304

Size:L460×W538×SH460×H820mm



- 38% lighter than steel chairs, easy to carry.
- Storage rooms saving by stacking up to 7 pieces.
- The rust-proof aluminum frames with exclusive wooden finish is totally waterproof and detachable cushions can be stored quickly, perfectly for outdoor using under various weather.
- The curved backrest designing provides more support and comfort even long time sitting.



BANQUET CHAIR



Code: BCD101
Size: L560×W575×SH460×H755mm

Code: BCD305
Size: L530×W620×SH481×H860mm



Code: BCD201
Size: L470×W566×SH465×H850mm

BANQUET CHAIR



Concise appearance in every dimension.



CODE : BC0202
SIZE : L460×W590×H854mm



CODE : BC0203
SIZE : L470×W600×H854mm

BANQUET CHAIR



Code: BC0301
Size: L455×W584×SH463×H915mm



Code: BC0103
Size: L510×W512×SH445×H850mm

Code: BC0302
Size: L440×W591×SH480×H966mm



Code: BC0303
Size: L460×W585×SH460×H930mm



Code: BC0102
Size: L490×W560×H930mm

MEETING TABLE

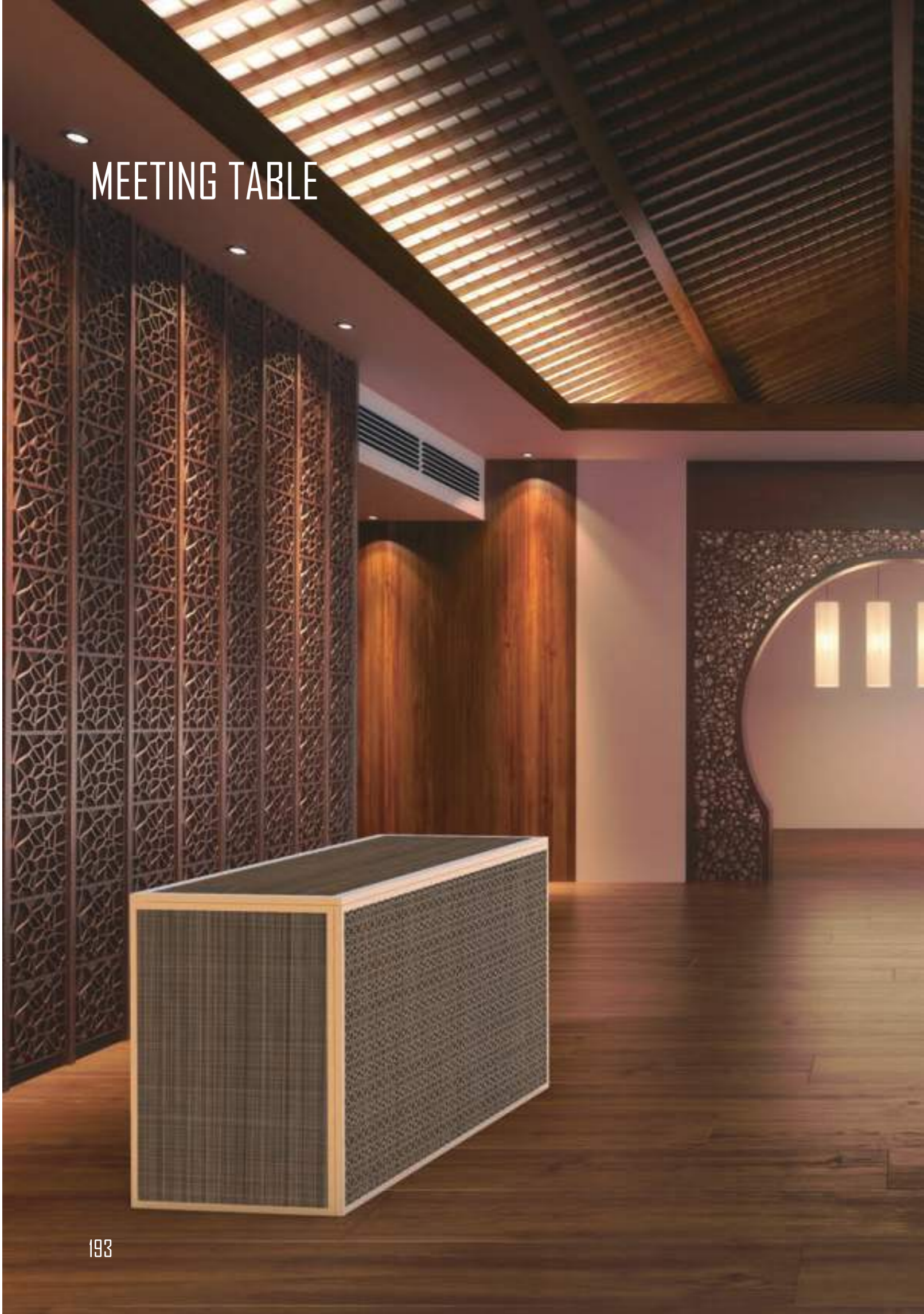

- #304 stainless steel, electroplated finishing
- Laminate on water resistant plywood
- 2 drawers
- 4 quite 2.5" wheels, high mobility and easy maneuverability



2 USB sockets

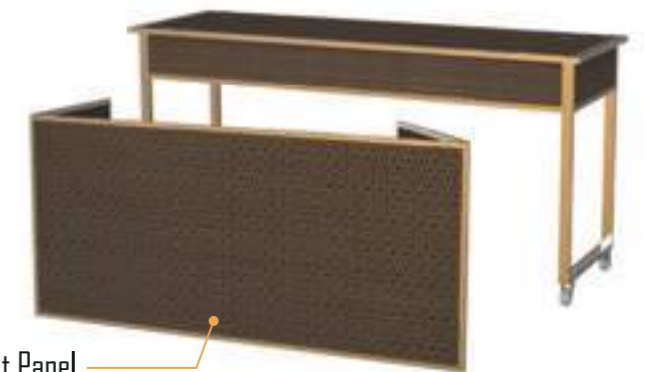

Detachable Foldable Front Panel

CODE : MT020101

SIZE : L1830×W600×H850mm



CODE : MT020102

SIZE : L1830×W600×H830mm



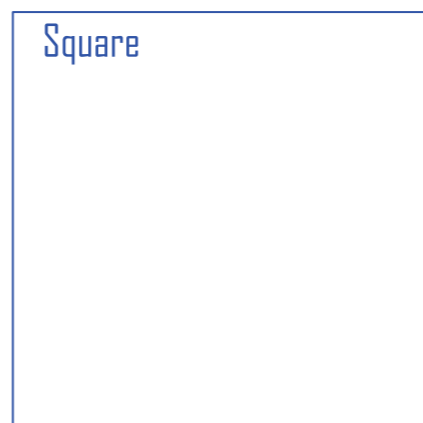
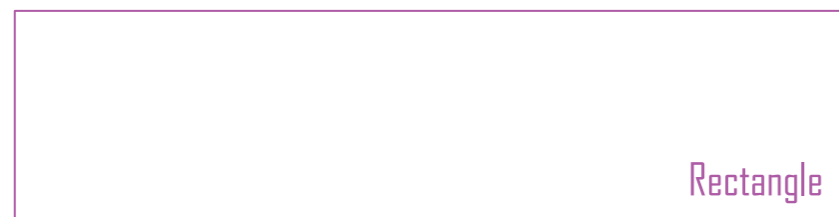
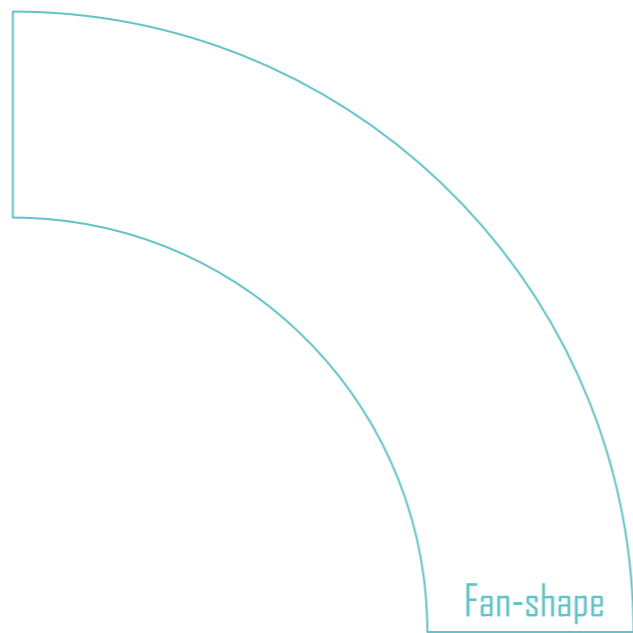
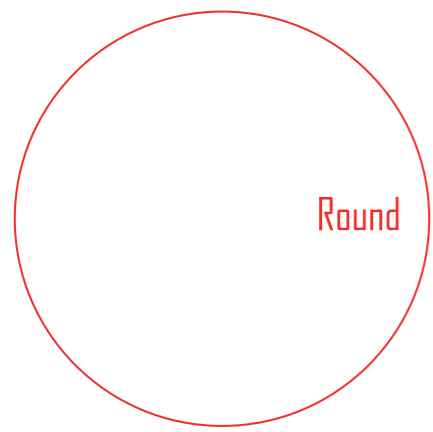



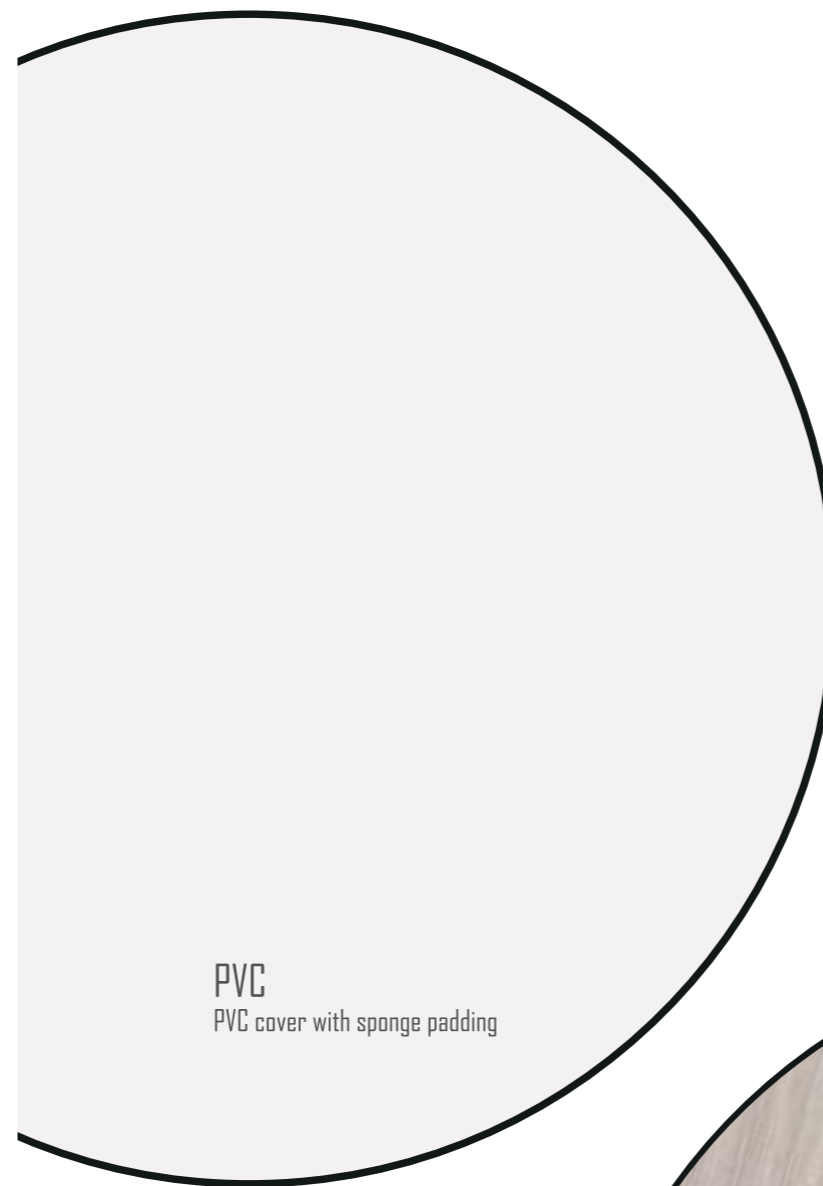
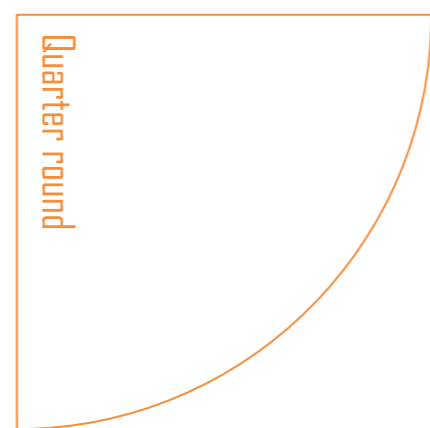



BANQUET TABLE

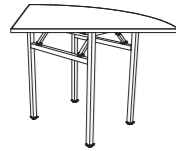





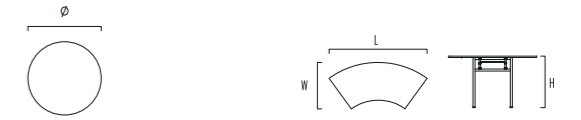

Steel Leg





ITEM	PVC	LEATHER	LAMINATE	SIZE
 <p>Round Table</p>	B80211-1P	B80211-1H	B80211-1L	D915×H760mm
	B80211-2P	B80211-2H	B80211-2L	D1220×H760mm
	B80211-3P	B80211-3H	B80211-3L	D1530×H760mm
	B80211-4P	B80211-4H	B80211-4L	D1680×H760mm
	B80211-5P	B80211-5H	B80211-5L	D1830×H760mm
	B80211-6P	B80211-6H	B80211-6L	D2000×H760mm
	B80211-7P	B80211-7H	B80211-7L	D2200×H760mm
 <p>Fan-shaped Table</p>	B80212-1P	B80212-1H	B80212-1L	L2103×W760×H760mm
	B80212-2P	B80212-2H	B80212-2L	L2130×W760×H760mm
	B80212-3P	B80212-3H	B80212-3L	L2873×W915×H760mm
	B80212-4P	B80212-4H	B80212-4L	L2154×W915×H760mm
	B80212-5P	B80212-5H	B80212-5L	L2150×W760×H760mm
 <p>Half Round Table</p>	B80214-1P	B80214-1H	B80214-1L	D915×H760mm
	B80214-2P	B80214-2H	B80214-2L	D1220×H760mm
	B80214-3P	B80214-3H	B80214-3L	D1530×H760mm
	B80214-4P	B80214-4H	B80214-4L	D1680×H760mm
	B80214-5P	B80214-5H	B80214-5L	D1830×H760mm
	B80214-6P	B80214-6H	B80214-6L	D2000×H760mm
	B80214-7P	B80214-7H	B80214-7L	D2200×H760mm
	B80214-8P	B80214-8H	B80214-8L	D2440×H760mm
	B80214-9P	B80214-9H	B80214-9L	D3000×H760mm
 <p>1/4 Round Table</p>	B80215-1P	B80215-1H	B80215-1L	L455×W455×H760mm
	B80215-2P	B80215-2H	B80215-2L	L760×W760×H760mm
	B80215-3P	B80215-3H	B80215-3L	L915×W915×H760mm
 <p>Square Round Table</p>	B80217-1P	B80217-1H	B80217-1L	L915/1220×W915/1220×H760mm
 <p>Square Table</p>	B80216-1P	B80216-1H	B80216-1L	L760×W760×H760mm
	B80216-2P	B80216-2H	B80216-2L	L915×W915×H760mm
	B80216-3P	B80216-3H	B80216-3L	L1220×W1220×H760mm
 <p>Rectangle Table</p>	B80213-1P	B80213-1H	B80213-1L	L1830×W455×H760mm
	B80213-2P	B80213-2H	B80213-2L	L1830×W760×H760mm
	B80213-3P	B80213-3H	B80213-3L	L1830×W915×H760mm

Buffet Table Combination



ITEM	OUTER	INNER	Qty	SIZE	Qty
 <p>2740 x H760mm</p>	2740mm	1220mm	1	L2150×W760×H760mm	
 <p>3350 x H760mm</p>	3350mm	1830mm	1	L2103×W760×H760mm	5
 <p>3660 x H760mm</p>	3660mm	1830mm	1	L2873×W915×H760mm	4
 <p>4870 x H760mm</p>	4870mm	1830mm	1	L2103×W760×H760mm	5
				L2130×W760×H760mm	7
 <p>5490 x H760mm</p>	5490mm	1830mm	1	L2873×W915×H760mm	4
				L2154×W915×H760mm	8
 <p>7320 x H760mm</p>	7320mm	1830mm	1	L2873×W915×H760mm	4
				L2154×W915×H760mm	8
				L2298×W915×H760mm	10

stainless steel leg

ITEM	LEATHER TABLE TOP CODE	SIZE
 <p>Fan-shaped Table</p>	B80222-1	L2103×W760×H760mm
	B80222-2	L2130×W760×H760mm
 <p>Rectangle Table</p>	B80223-1	L1830×W455×H760mm
	B80223-2	L1830×W760×H760mm
	B80223-3	L1830×W915×H760mm
 <p>Round Table</p>	B80221-1	D1830×H760mm
 <p>1/4 Round Table</p>	B80224-1	L455×W455×H760mm
	B80224-2	L760×W760×H760mm
	B80224-3	L915×W915×H760mm

PARTITION

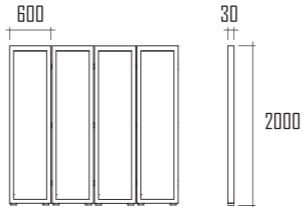

CODE : PT070002
 SIZE : L600×W30×H2000mm*4

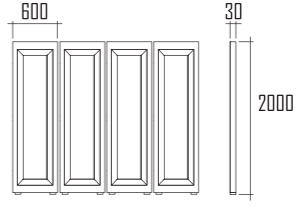

CODE : PT070001
 SIZE : L600×W30×H2000mm*4

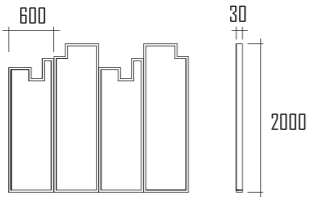

CODE : PT070003
 SIZE : L600×W30×H2000mm*4

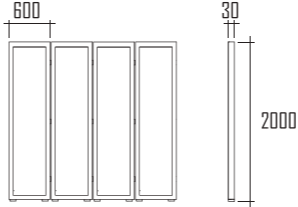

CODE : PT060000
 SIZE : L600×W30×H2000mm*4



PODIUM

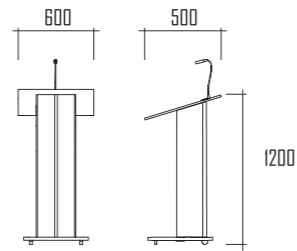

CODE : PDD70001
 SIZE : L600×W500×H1200mm

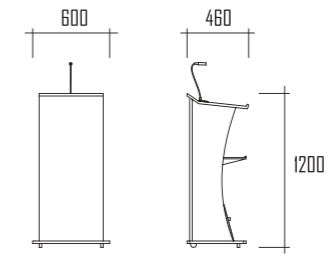

Code: PDD70002
 Size: L600×W460×H1200mm

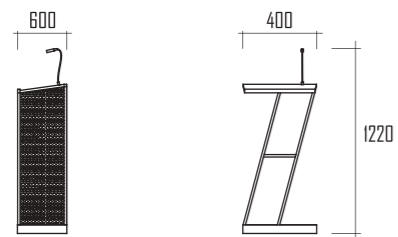

CODE : PDD70003
 SIZE : L600×W400×H1220mm

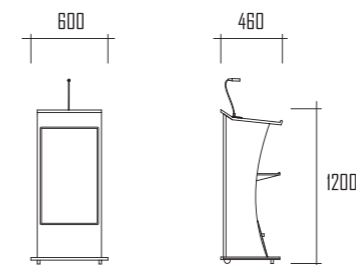

CODE : PDD70004
 SIZE : L600×W460×H1200mm

